

VTS-110

OPERATOR'S MANUAL



THIS MANUAL IS ALSO APPLICABLE TO
MODELS VTS-100S AND VTS-110 DX.

AKAI[®]

MANUFACTURED & DISTRIBUTED BY AKAI ELECTRIC CO., LTD./AKAI TRADING CO., LTD.

1. SPECIFICATIONS (Models VTS-110 DX/VTS-110/VTS-100S)

VT-110 PORTABLE VIDEO TAPE RECORDER

TV Signal	U.S.A. Standard TV signal (Also available for C.C.I.R. Standard TV Signal. C.C.I.R. Specifications shown in blue).
Recording System	Twin rotating head, Frequency Modulation System
Recording Time	20 min. using a 1,100 ft. tape (24 minutes)
Tape Speed	11-1/4" per second (238.5 mm per second)
Tape Width	1/4"
Maximum Reel Capacity	5" Reel
Resolution	More than 200 lines
Video Signal to Noise Ratio	Better than 40 dB
Video Input	1.4 Vp-p, 75 Ω
Audio Input (external mic)	-65 dB, 600 Ω
Audio Frequency Band Width	100 to 10,000 Hz
Audio Signal to Noise Ratio	Better than 38 dB
Semi-conductors	41 silicon transistors 20 diodes 1 FET 6 Uni-Junctions
Integrated Circuits	26
Power Source	DC 12 V (Two 6 V batteries or VA-110 AC Adapter)
Batteries	2 rechargeable 6 V batteries
Battery Using Time	60 continuous minutes
Battery Recharge Time	8 hours
Power Consumption	14 W (without camera and monitor)
Dimensions	255(W) x 112(H) x 263(D) mm (10" x 4.4" x 10.3")
Weight	5 kg (11 lbs.)

VC-110 VIDEO CAMERA

Tube	2/3" Vidicon Tube
------	-------------------

Scanning System	External System (supplied from VT-110, VT-100S)
Horizontal Resolution	More than 400 lines
Horizontal Frequency	15.75 kHz (15.625 kHz)
Vertical Frequency	60 Hz (50 Hz)
Video Signal to Noise Ratio	Better than 40 dB
Video Output	1.4 Vp-p, composite signal
Aperture Selector	F1.8 and F5.6
Lens	Zoom lens 10 to 40 mm (VC-110S : 9 to 54 mm)
View Finder	One-eye reflex system
Power Source	DC 9 V (supplied from VT-110, VT-100S)
Focus Adjustment	Micro Split-image
Microphone	Uni-directional built-in mic, 600 Ω
Dimensions	75(W) x 113(H) x 187(D) mm (3" x 4.4" x 7.3")
Weight	1.9 kg (4.1 lbs.) (VC-110S : 2.2 kg (4.8 lbs.) including grip)

VA-110 ADAPTER

Power Supply	AC 100 to 240 V, 50/60 Hz
Selector Switch	DC output/battery charge & DC/battery charge
Dimensions	111(W) x 92(H) x 200(D) mm (4.3" x 3.6" x 7.8")
Weight	27 kg (5.9 lbs.)

VM-110 PORTABLE MONITOR

Picture Tube	3"
Video Input	1.4 Vp-p, 75 Ω
Audio Input	1 V RMS, 10 k Ω
Speaker	75 x 44 mm (3" x 1.7")
Max. Audio Output	120 mV
Power Source	DC 12 V supplied from VT-110, VT-100S
Power Consumption	3.5 W
Dimensions	98(W) x 112(H) x 263(D) mm (3.8" x 4.4" x 10.3")
Weight	1.6 kg (3.5 lbs.)

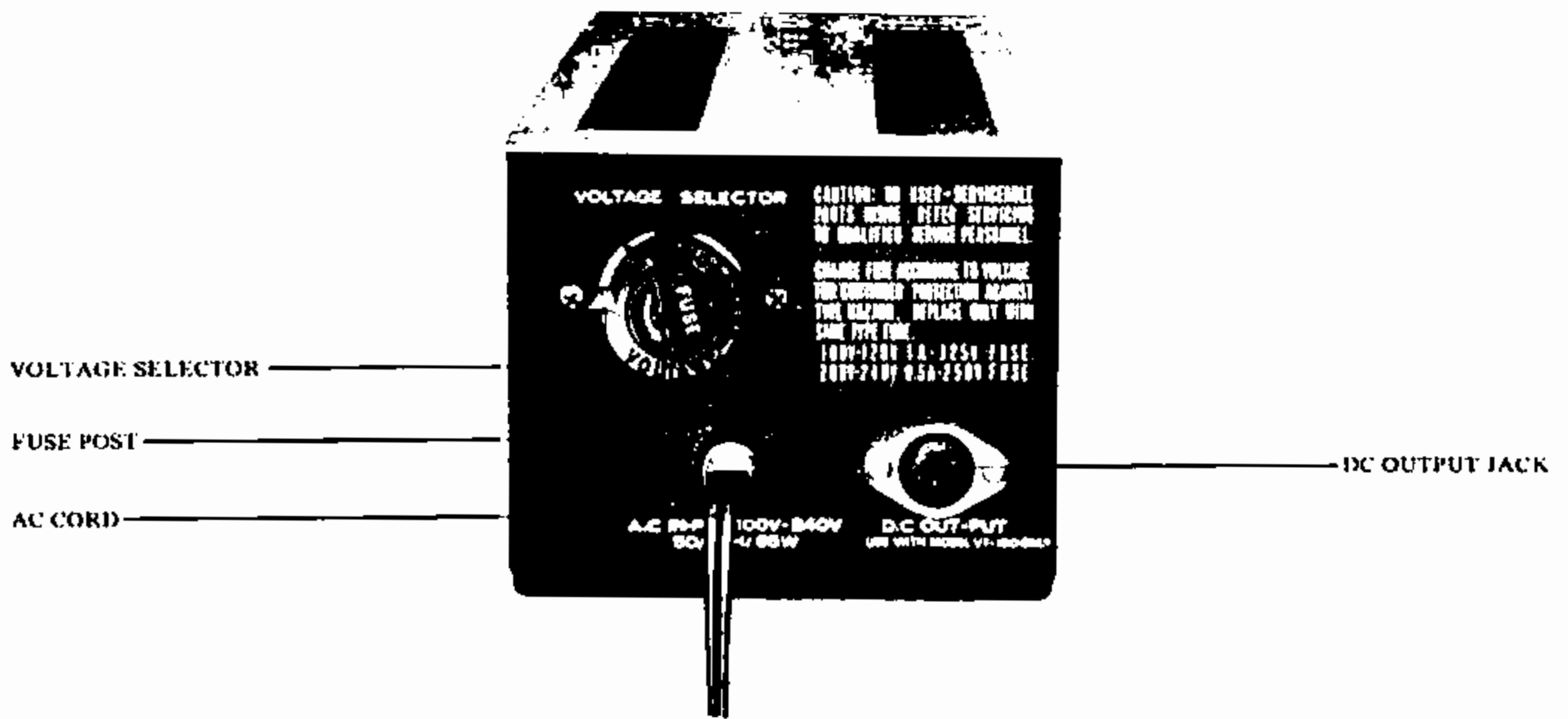

Fig. 7

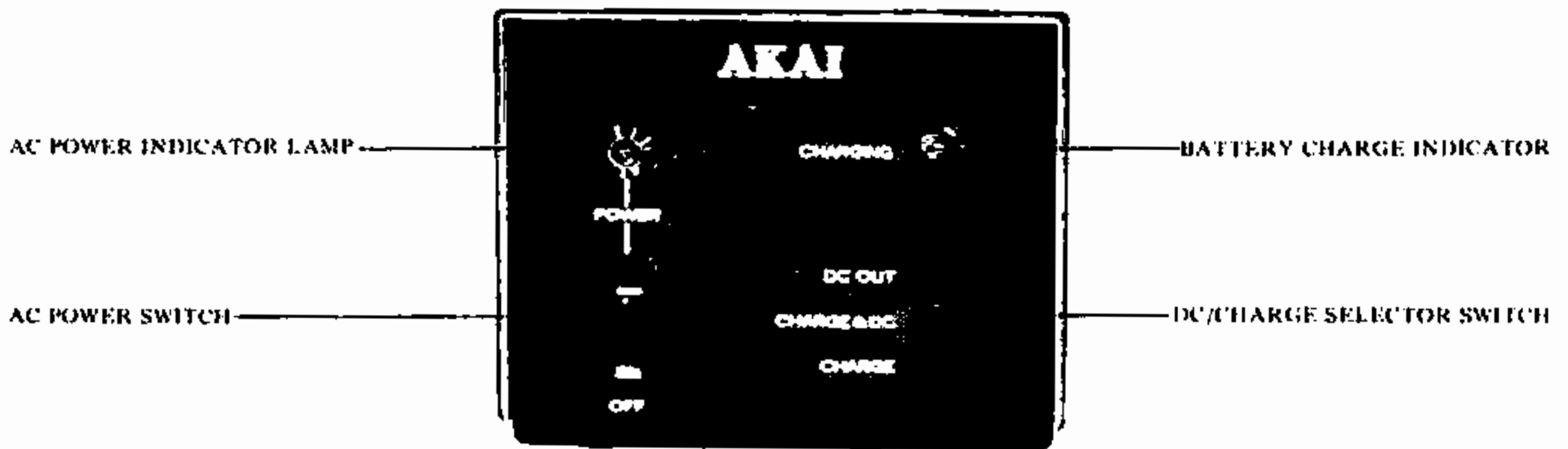

Fig. 8



Fig. 9

TABLE OF CONTENTS

1. SPECIFICATIONS	1
2. CONTROLS	2
3. GENERAL INFORMATION AND OPERATING PRECAUTIONS	5
4. VT-110 RECORDER	6
HEADS	6
LOADING AND THREADING VIDEO TAPE	6
BATTERY LOADING	7
TAPE VIEW WINDOW	7
CONNECTING TV MONITOR VM-110 AND RECORDER VT-110	7
5. RECORDING	8
OFF AIR RECORDING	9
SOUND DUBBING	10
6. PLAY BACK	11
PLAYBACK USING VM-110 MONITOR	11
PLAYBACK USING EIAJ STANDARD MONITOR TV	11
PLAYBACK USING YOUR HOME TV SET	12
7. VC-110 CAMERA	12
FOCUSING	12
TAPE INDICATOR LAMP	13
APERTURE SWITCH	13
APERTURE SWITCH INDICATOR	13
8. VA-110 AC ADAPTER	13
ADAPTER POWER VOLTAGE ADJUSTMENT ...	14
CHARGING BATTERIES	14
9. TAPE SPLICING AND EDITING	15
10. TAPE ERASING	15
11. HEAD DEMAGNETIZING	15
12. ACCESSORIES	16
STANDARD ACCESSORIES	16
OPTIONAL ACCESSORIES	16

2. CONTROLS

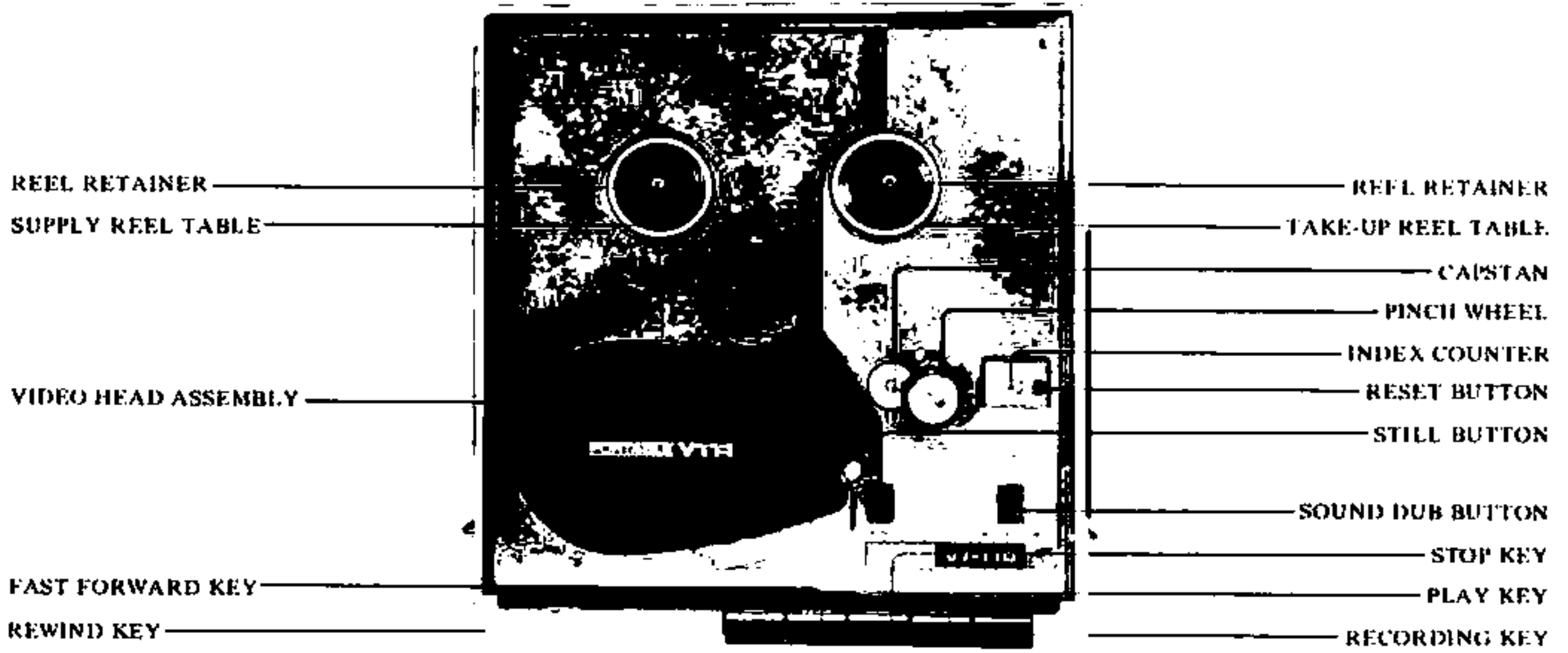

Fig. 1



Fig. 2

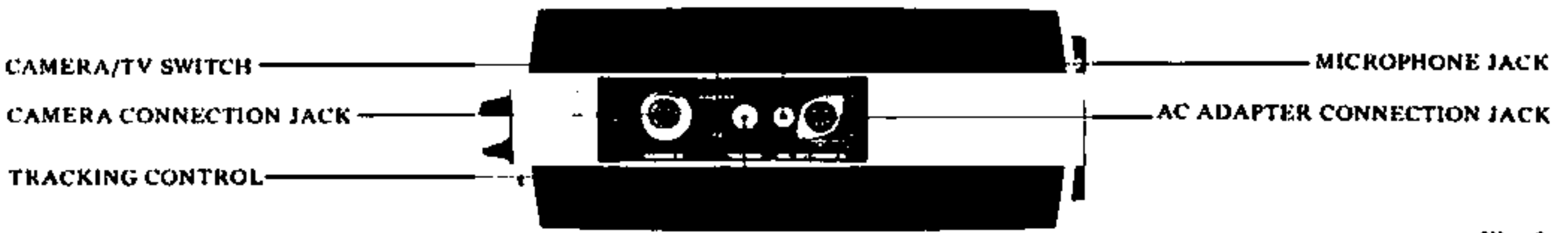

Fig. 3



Fig. 4

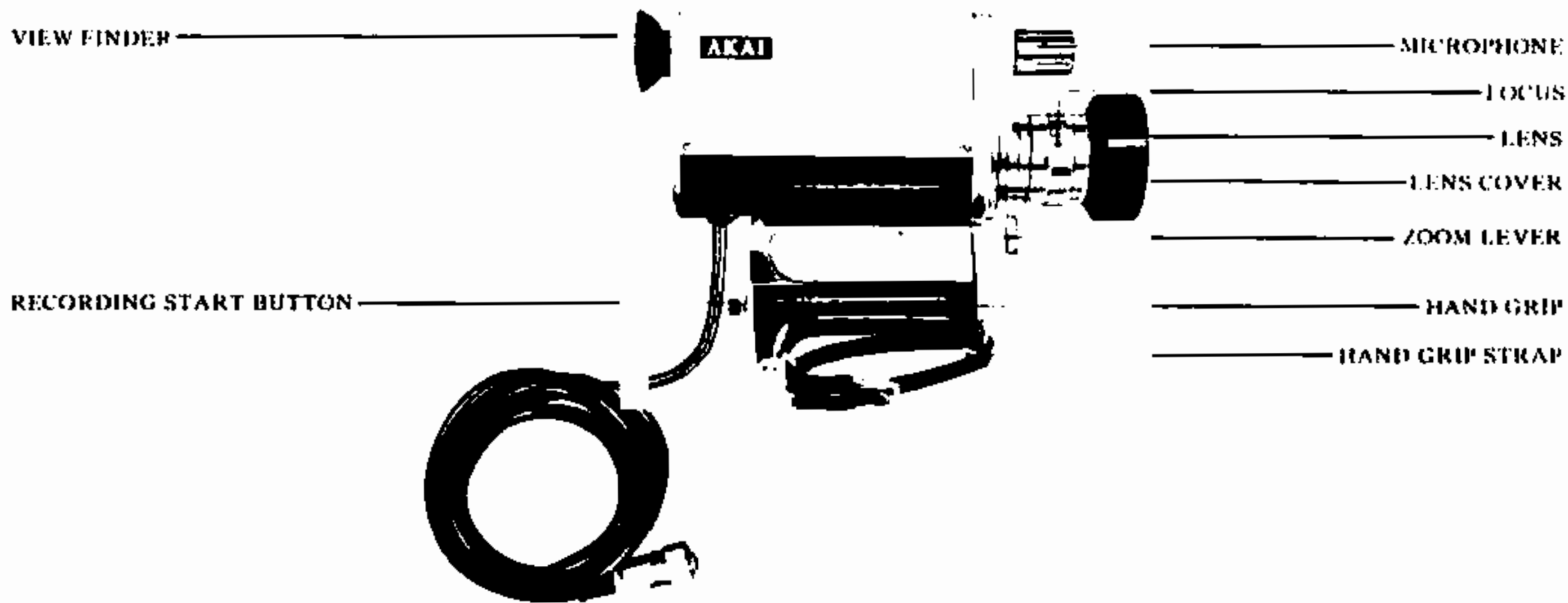

Fig. 5

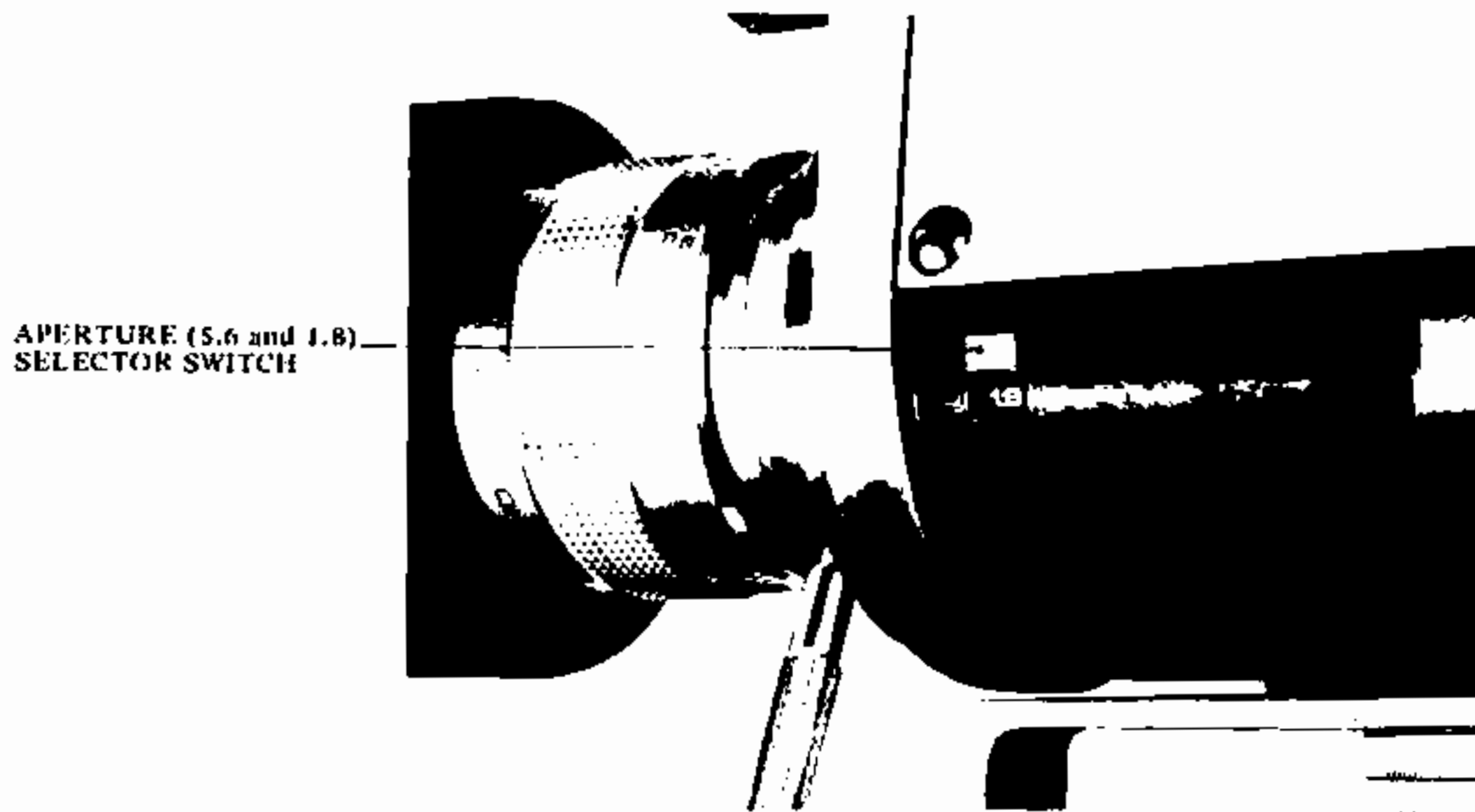

Fig. 6

3. GENERAL INFORMATION AND OPERATING PRECAUTIONS

The VTS-110 Video Tape Recorder set is an easy to handle portable combination capable of recording video with accompanying sound track.

Among the unique features of this model is it's ability to utilize 1/4" video tape, the automatic light compensator, and automatic audio/video recording level controls. These automatic recording level devices assure consistency in attaining clear and sharp sound and picture.

Video recording requires the tapes full width ; therefore, recording/playback is performed in one direction only.

Your new portable V.T.R. Set is constructed of the finest materials and if operated properly will bring you many, many hours of video/audio enjoyment. We, therefore, urgently request that you read this entire manual thoroughly before attempting any of the diversified operations described therein.

Kindly observe the following operating precautions as well as those found throughout this manual.

1. A video head assembly guard has been installed to protect the video heads during shipment. Please be sure to remove this guard before attaching equipment or turning on power switch.

2. Be sure to turn off the power switch before loading or unloading tapes.
3. For quality recordings, always use highest quality video tapes. At the present, only AKAI's specially designed 1/4" video tape (VT-5) is recommended. Other tapes may be approved by AKAI as they become available.
4. Do not expose camera lens to direct sunlight. This will damage the videcon regardless of whether the camera is being operated or not.
5. Avoid placing camera in downward position. When lens are pointed directly downward (during transportation, etc.), there is danger that they will be damaged by vibration. Always place camera in vertical or upright position.
6. Discarded batteries should not be left in reach of children as they contain acid.

Should any mechanical problem develop, please take your machine to the nearest authorized AKAI VTR agent in your area or inquire at the Service Department of AKAI Company, Tokyo, Japan.



Fig. 10



Fig. 11

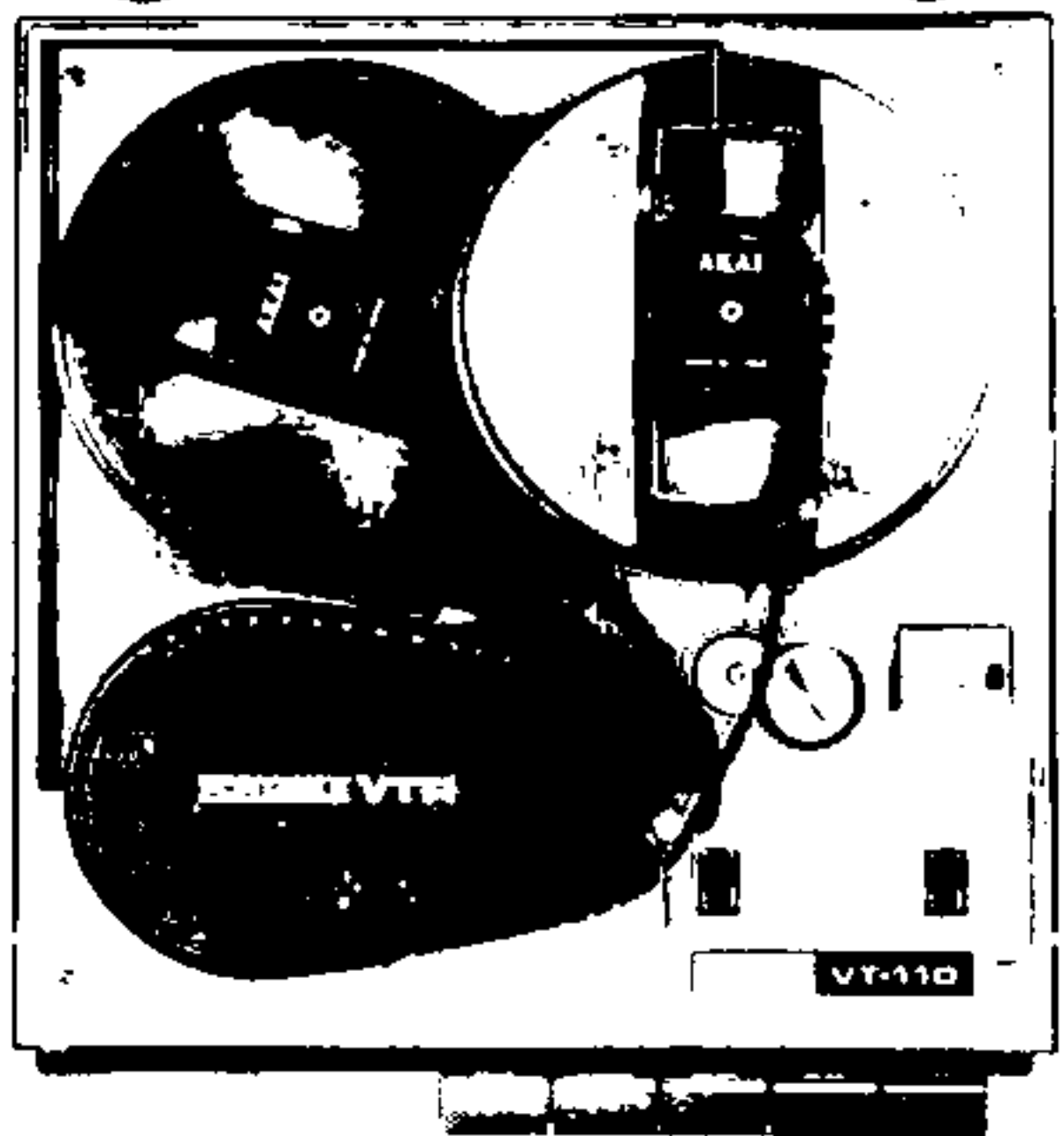

Fig. 12

4. VT-110 RECORDER

■ HEADS

Model VT-110 is equipped with two rotating video heads mounted inside the video head assembly, plus stationary Full Track Erase, Control/Audio, and Side Track Erase heads.

DO NOT TOUCH VIDEO HEADS. Video head cleaning should be performed only by an authorized AKAI V.T.R. Service Agent. For cleaning stationary heads, use a clean piece of chamois soaked in Freon Liquid or Alcohol.

Caution :

To avoid damaging or soiling the heads, do not touch the head surfaces with any kind of object or with your hands.

For protection of the video heads :

- a. Use only AKAI video tapes. The use of ordinary tape will shorten the life of the video heads.
- b. When editing tapes, be sure that the ends are evenly aligned and that the splicing tape adhesive is firmly applied. If the tape is poorly spliced and is not completely smooth, the video heads will be irreparably damaged as they pass over the splice.
- c. Do not touch the rotating video heads.

■ LOADING AND THREADING VIDEO TAPE

Caution :

The video head assembly of your VT-110 is equipped with a head protector for protection of the video heads during transportation. It is therefore necessary to remove the protector before attempting to load tapes.

To load tape for recording/playback, proceed as follows :

1. Raise case lid.
2. Place full reel of tape on Supply Reel Table, and empty reel on Take-Up Reel Table (Use only the highest quality 1/4" video tape. Inferior quality tape will shorten the life of the video heads).
3. Lock reels into place with Reel Retainers provided on reel shafts.
4. Thread the tape as illustrated by the dotted line in Fig.12
5. Insert end of tape in slot of empty Take-Up Reel and turn by hand to wind tape around reel hub one or two times.



Fig. 13

■ BATTERY LOADING

Your VT-110 employs two Type D rechargeable batteries. Instructions for loading are clearly written on the inside of the battery lid.

Your VT-110 is equipped with a Battery Voltage Indicator. When the Battery Voltage Indicator reaches the white line between green and red, the batteries must be recharged. **DO NOT WAIT UNTIL THE INDICATOR REACHES THE RED ZONE.** For re-charging instructions, see page 14 of this manual.



Fig. 14

■ TAPE VIEW WINDOW

Your VT-110 is equipped with a Tape View Window (Fig. 14). Tape position can easily be determined without opening the recorder lid.

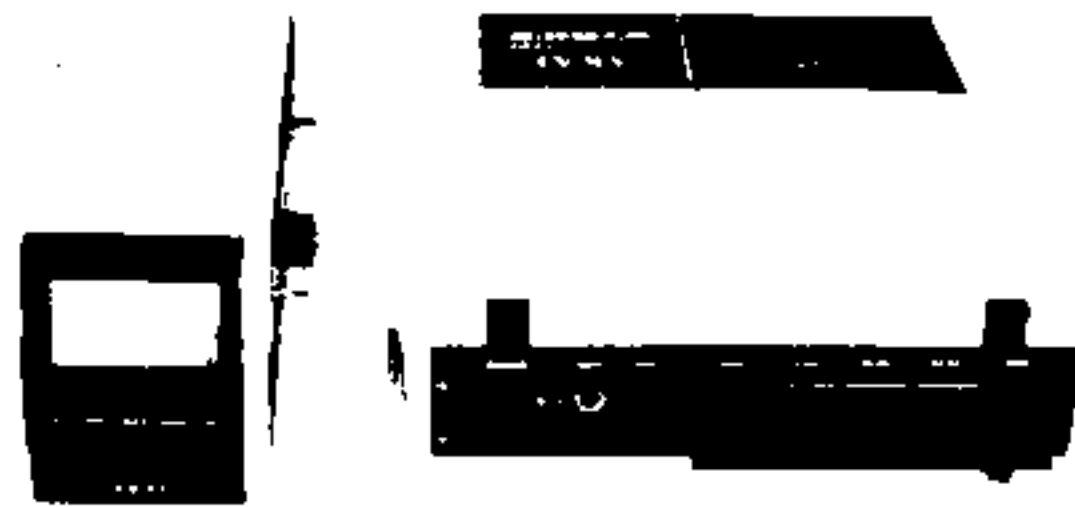

Fig. 15

■ CONNECTING TV MONITOR VM-110 AND RECORDER VT-110

As shown in Fig. 15, line up the VM-110 with the VT-110 and connect the VM-110's protruding plug into receptacle provided on the left side of VT-110.

Fit the two units together tightly and tighten screws A and B (Fig. 15).

When separating TV Monitor and Recorder, reverse the above procedure.

Note :

Video recording is possible even with the VM-110 separated from the recorder. However, if they are connected, the operator is able to perfectly focus the picture being recorded while viewing the monitor screen.

Note :

VMC-3 Monitor Connection Cord (optional accessory) can also be used for connecting the VM-110 to the VT-110.

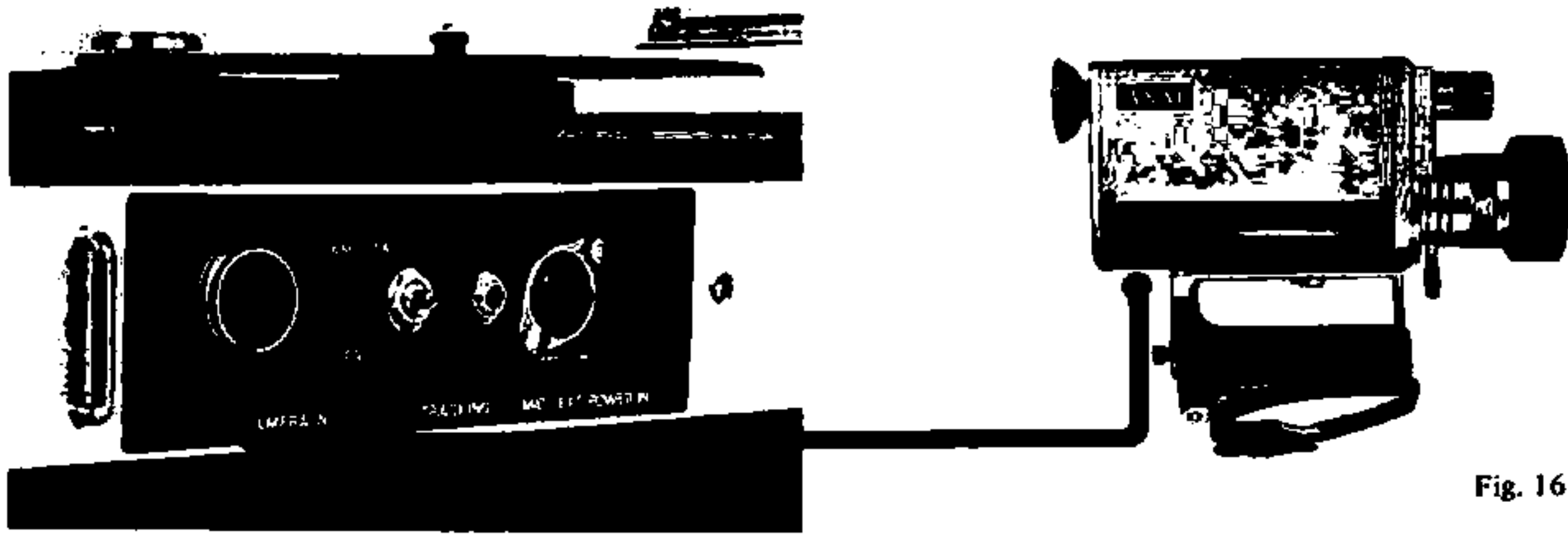

Fig. 16

5. RECORDING

From Camera

1. Connect Model VC-110 Camera to the Camera In Jack.
2. Load a tape (Refer to Tape Loading procedure on page 6).
3. Turn on Power Switch. (If batteries are being used, set switch to "BATT ON" position. If AC Adapter is being used, set switch to "BATT OFF/AC" position and turn on Adapter Power Switch).
4. Simultaneously push Recording Safety Lever (A) (Fig. 17A) to the right and depress Recording Key (B) to lock into recording position.
5. Set Aperture Switch and focus camera (Refer to Page 13 of Camera operating instructions).
6. If handle is attached to camera, press Start Button on camera to start recording (Remote Control).
7. If handle is detached operate Recording Key and lock button (Fig. 17A) to start recording. The audio is recorded by means of the camera's built-in microphone. If Monitor TV VM-110 is attached, a quick glance at the monitor screen will confirm that the picture is being properly recorded.

Note :

Audio monitoring can be done through the use of earphones. Connect earphones to Earphone Jack located on front panel of the VT-110. Earphones should be of 600 ohm impedance.

Optional Accessory VOA-5 is recommended.

When making a video recording, if your wish to use an external microphone for companion audio pick-up instead of the camera's built-in microphone, connect external microphone to External Microphone Jack (Fig. 18).

External microphone should be of 600 ohm impedance type. Optional Accessory VOA-7 is recommended.

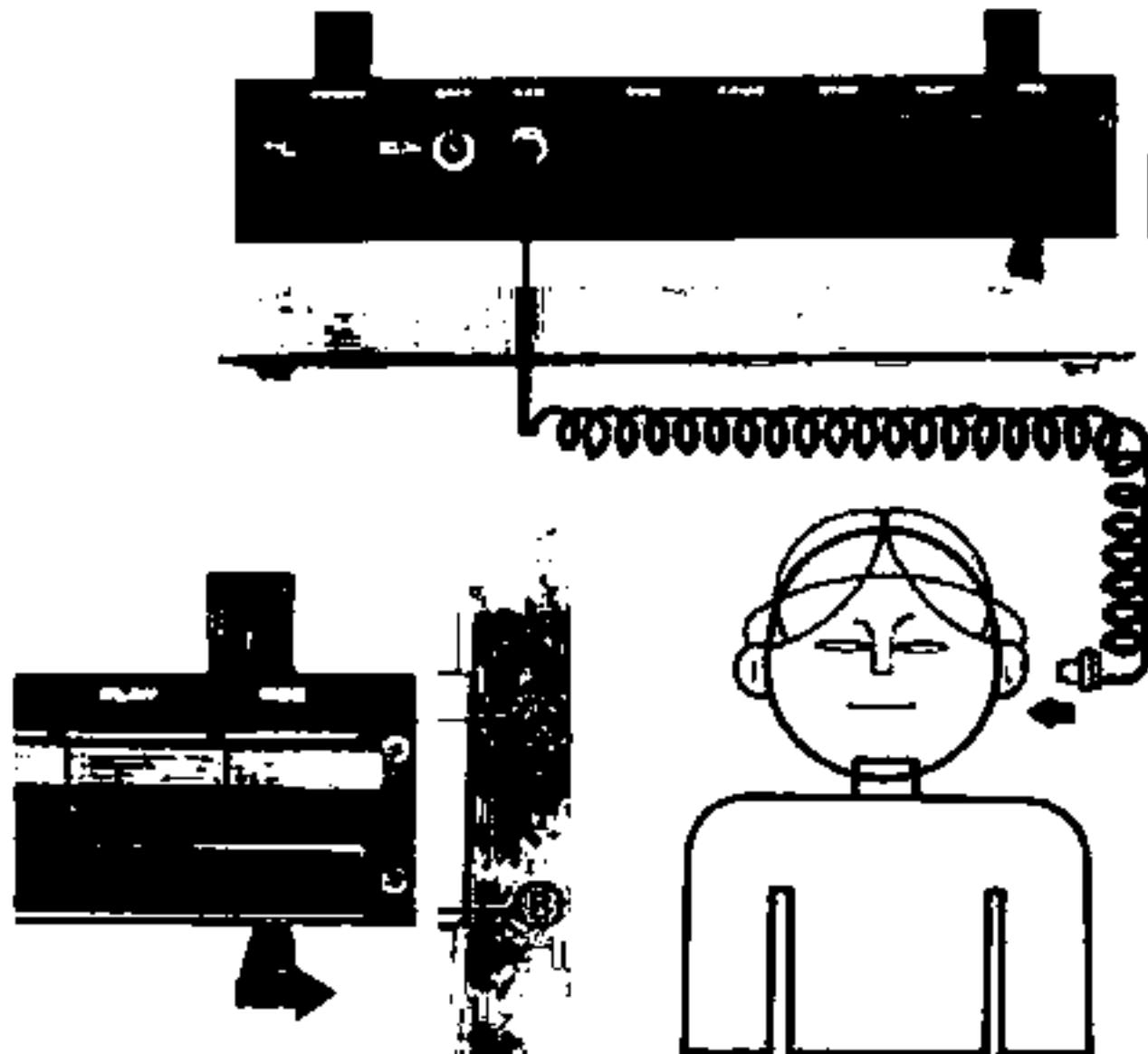

Fig. 17A

Fig. 17

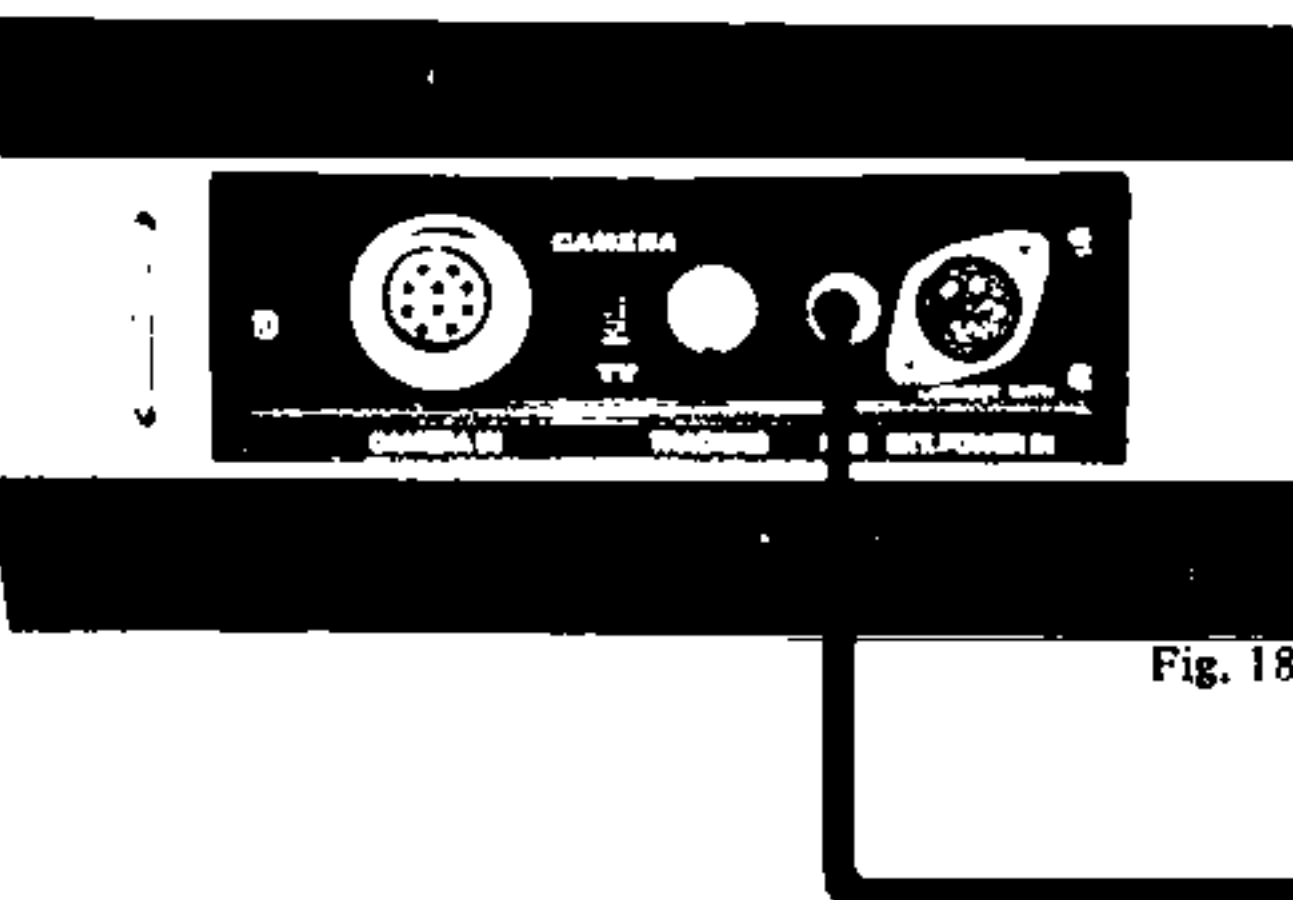

Fig. 18

■ OFF AIR RECORDING (VT-110 ONLY)

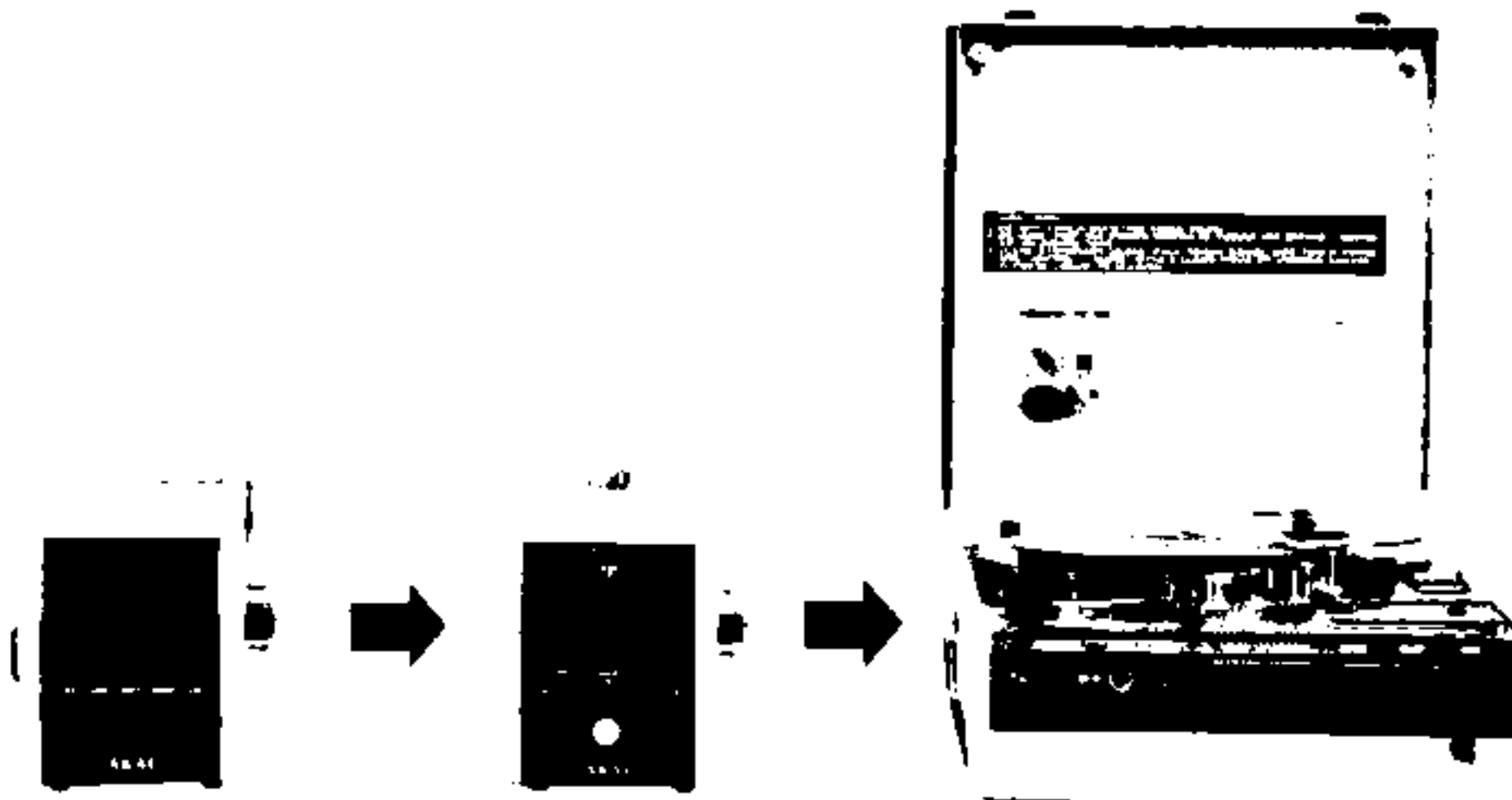

Fig. 19

Separate the VM-110 from Model VT-110 (refer to page 7 of this manual). Connect an AKAI TV Tuner to the Monitor Socket as the side of Model VT-110, and connect the VM-110 Monitor TV to the TV Tuner (Fig. 19).

Note :

If your home TV is used instead of model VM-110, it must be connected to the TV Tuner through an AKAI RF Converter.

1. Load a tape (refer to Tape Loading procedure, page 6).
2. Set TV/Camera Switch to "TV" position.
3. Turn on Power Switch (If batteries are being used, set switch to "BATT ON" position. If AC Adapter is being

used, set switch to "BATT OFF/AC" position and turn on Adapter Power Switch).

4. Turn on TV Monitor.
5. Set TV Tuner TV/VTR Switch to "VTR" position and tune in station while viewing monitor screen (If necessary, make adjustments at monitor).
6. After proper adjustments have been made, simultaneously push Recording Key to begin recording.
7. To stop recording, depress Stop Key.

Note :

For "on the spot" playback, simply rewind tape and depress Play Key.

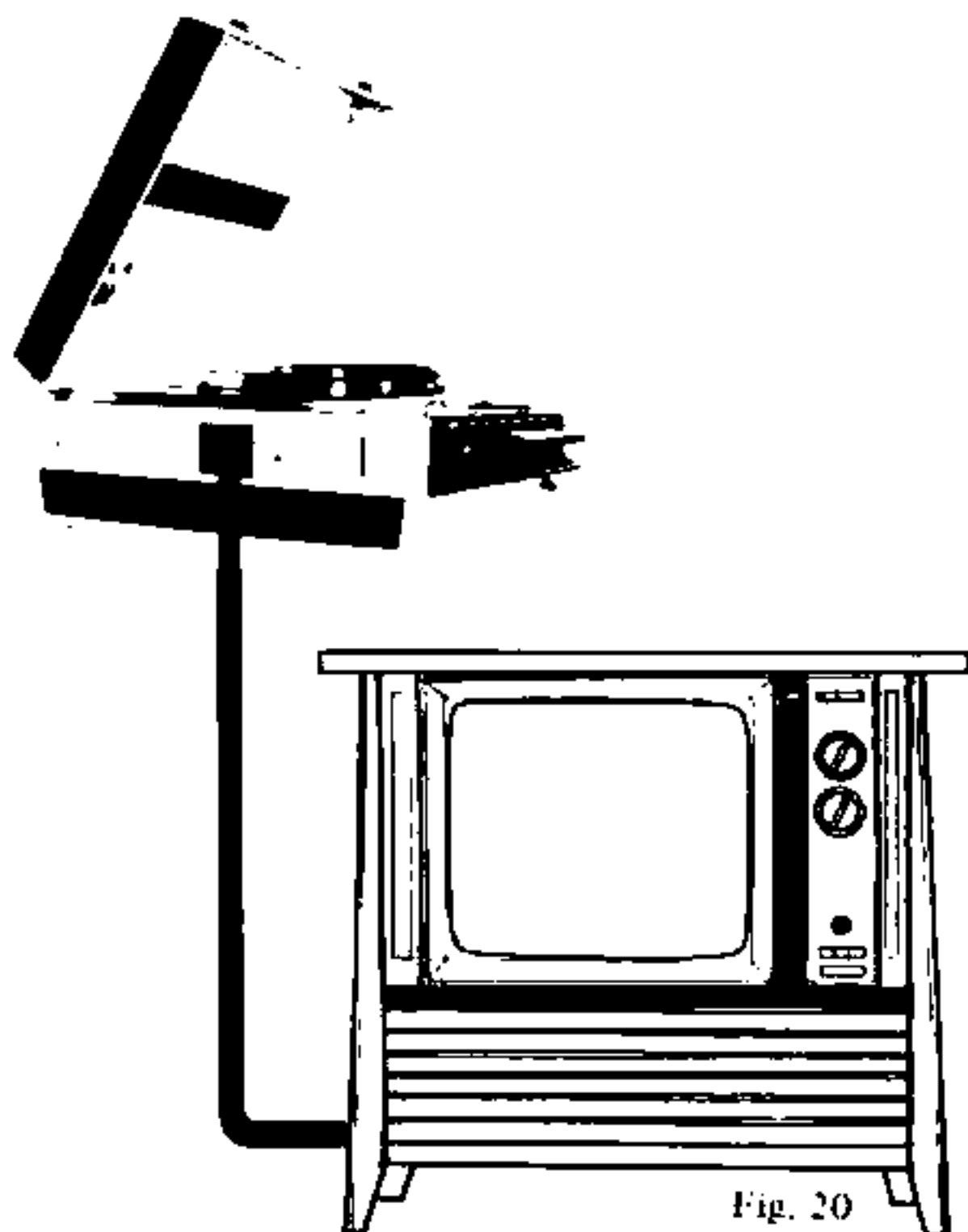

Fig. 20

An EIAJ Standard monitor TV can also be used for "off-air" recording. In this case, the monitor TV can be connected directly to the recorder by means of a Model VC-V-2 Recorder/TV connection cable (optional accessory). (Fig. 20). Follow steps 1, 2, and 3 of the above procedure and continue as follows :

4. Tune in TV Station and set TV/VTR Switch to "VTR" position.
5. Simultaneously push Recording Safety Button to right and depress Recording Key to begin recording.
6. To stop recording, depress Stop Key.

Note :

For "on the spot" playback, simply rewind tape and depress Play Key.



Fig. 22

■ SOUND DUBBING (VT-110 ONLY)

For Sound Dubbing (after recording), rewind tape and insert microphone plug into External Microphone Jack. Set Sound Dub Button to "Sound Dub", Camera-TV Switch to "Camera" position, and depress Play Key. Dub sound through microphone while viewing picture on video monitor screen.

For video/audio transfer from Model V1-110 to model VT-700, connect TV/Recorder Cable to the monitor plug connection of Model V1-110 and to the TV Connection plug at the rear of Model V1-700.

Set Model VT-110 to normal playback mode and set Model VT-700 to Recording Mode.

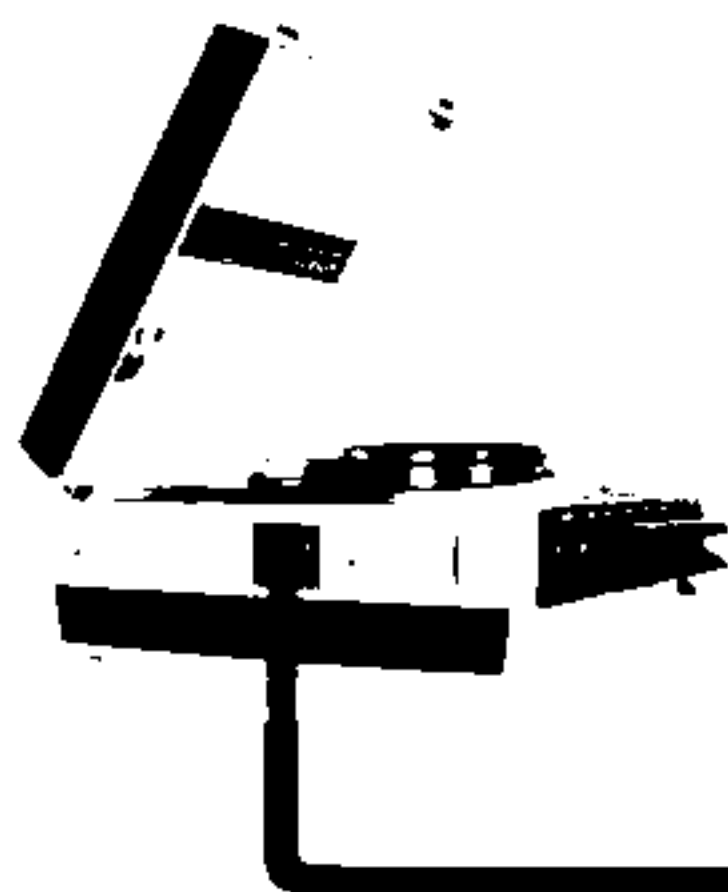

Fig. 23

Note :

If VDC-1 Dubbing Cord (optional accessory) is used instead of TV/Recorder Cable, the program can be monitored as it is being transferred. The VDC-1 Dubbing Cord is a 3-way connection cable and also connects to the VM-110 Monitor. Video/audio transfer can also be accomplished by using two VT-110 Models. In this case use the 3-way Dubbing Cord model VDC-2.

6. PLAYBACK

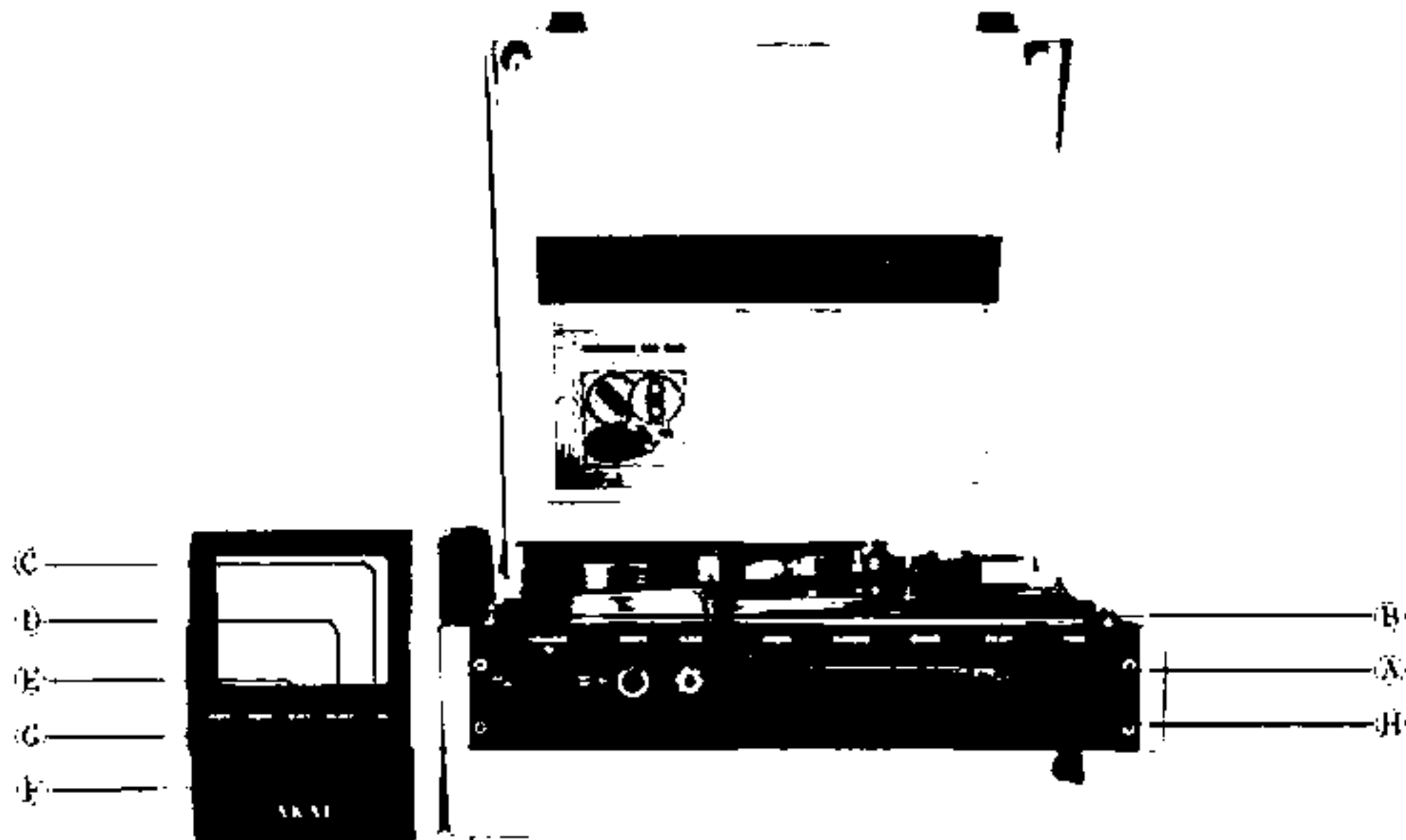

Fig. 24

■ PLAYBACK USING VM-110 MONITOR

1. Rewind or load tape as described on page 6.
If you have just completed your video tape recording and have rewound the tape, merely depress Play Key (A) for easy playback.
2. If batteries are being used, set Power Switch (B) to "BATT ON" position and turn Volume Control Power Switch Knob (C) of Monitor receiver clockwise until it "clicks" on. If AC Adapter is being used, set Power Switch (B) to "BATT OFF/AC" position and follow the same procedure.
3. Depress Play Key (A) to begin tape playback. Adjust

volume of audio playback at Monitor Volume Control (C).

4. Adjust the vertical, horizontal, brightness, and contrast by operating Control Knobs (D), (E), (F), and (G) of monitor.
5. When playing back tapes which have been recorded on other AKAI Video Tape Recorders, video tracking adjustment (fine adjustment) may be necessary. In this case, with a small screw driver, adjust Tracking Control on side panel.
6. For a still picture during playback (to stop tape, but allow picture to remain on screen), set Still Button to "Still" position and depress Stop Key.
7. Depress Stop Key (H) at conclusion of playback.

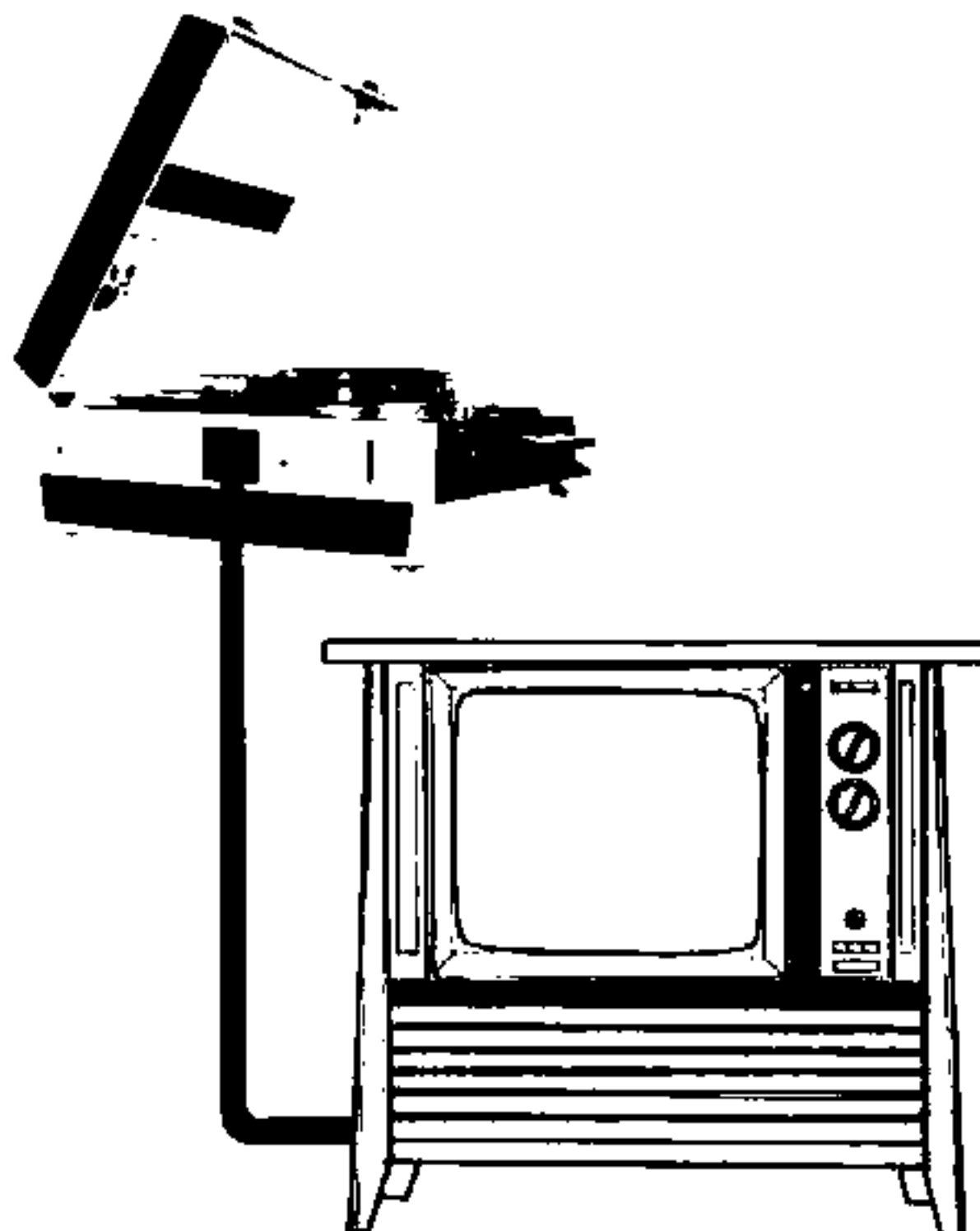

Fig. 25

■ PLAYBACK USING EIAJ STANDARD MONITOR TV

Separate the VM-110 from the VT-110 (See page 7), and connect the Monitor to the Monitor Socket of Model VT-110 by means of VCV-2 Monitor cord (optional accessory).

1. Load a pre-recorded tape (Refer to Tape Loading procedure, page 6).
2. Turn on Power Switch and set TV/VTR Switch to "VTR" position.
3. Set Camera/TV Switch to "TV" position. (VT-110 only).
4. If batteries are being used, set Power Switch (B) to "BATT ON" position. If AC Adapter is being used, set Power Switch to "BATT OFF/AC" position and turn on Adapter Power Switch.
5. Depress Play Key to begin playback. Adjust volume, etc. at Monitor TV.
6. When playing back tapes which have been recorded on other AKAI Video Tape Recorders, video tracking (fine adjustment) may be necessary. In this case, with a small screw driver, adjust Tracking Control on side panel.
7. For a still picture during playback (to stop tape, but allow picture to remain on screen), set Still Button to "Still" position and depress Stop Key.
8. Depress Stop Key at conclusion of playback.

■ PLAYBACK USING YOUR HOME TV SET

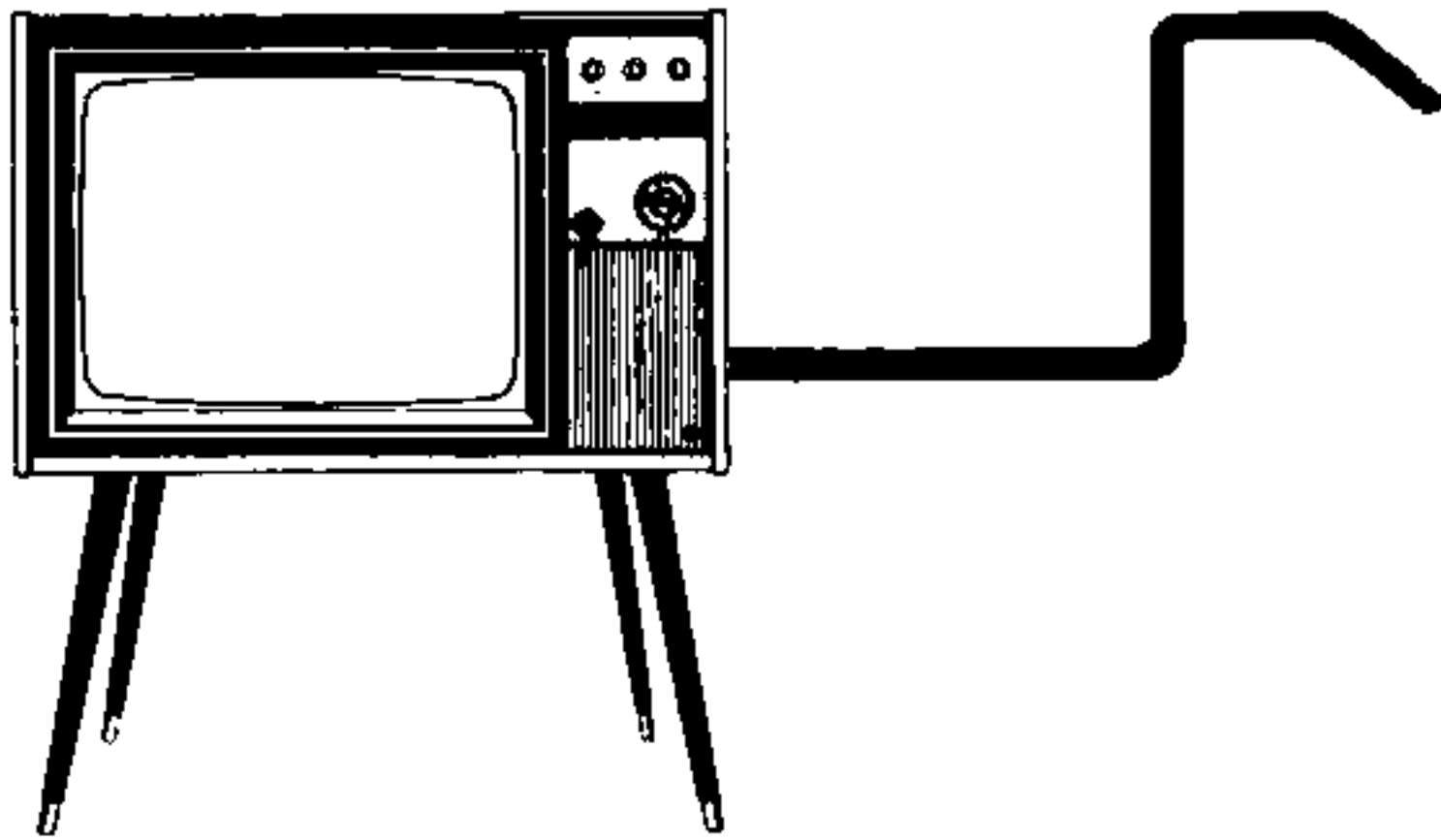

Fig. 26

To utilize an empty channel of an ordinary TV Set for playback, an AKAI RF Converter must be used. Connect Converter to Monitor Socket of Model VT-110.

Disconnect the 300 or 75 ohm antenna terminals of your TV Set and connect the other end of converter cord to these terminals.

Substitute the following Step (2) of Playback Using



Monitor TV procedure and follow the rest of the procedure.

(2) Turn on TV Set and set to Area Blank Channel.

IMPORTANT :

In purchasing an RF Converter, please choose a Model Number to correspond with the blank channel in your area.

7. VC-110 CAMERA

Your television camera VC-110 is specially designed to operate as part of your Model VT-110 VTR Set. Connect camera and recorder as shown in Fig. 27.

The camera is compact, lightweight and easy to operate. With this video system, the scope of live video television is as unlimited as the imagination of the operator.

1. Hold camera by handle in right hand as shown in Fig. 28.
2. Remove Lens Cover. While viewing subject through View Finder (A), with left hand, adjust Zoom Lens Lever (B) and Focus (C) to desired positions.
3. Select Aperture (5.6 or 1.8) with Aperture Selector.
4. When desired adjustments have been made, with right thumb, depress remote control Recording Switch (D) to start recording.
5. A 600 ohm uni-directional microphone (E) is built into the camera for audio recording.

■ FOCUSING

Zoom to maximum and adjust the micro split-image of picture in the center of the view finder so that the picture comes together perfectly. If Visibility Adjustment is not correct, perfect focusing cannot be accomplished.

VISIBILITY ADJUSTMENT

For visibility adjustment, proceed in the following order :

1. Loosen double nut on view finder (turn to left)
2. Aim camera at something like the surface of a white wall, and with both eyes open, while looking through view finder, rotate rubber cap until micro split image is at clearest position.
3. Without further rotation of rubber cap, tighten double nut to hold at adjusted position (turn to right).

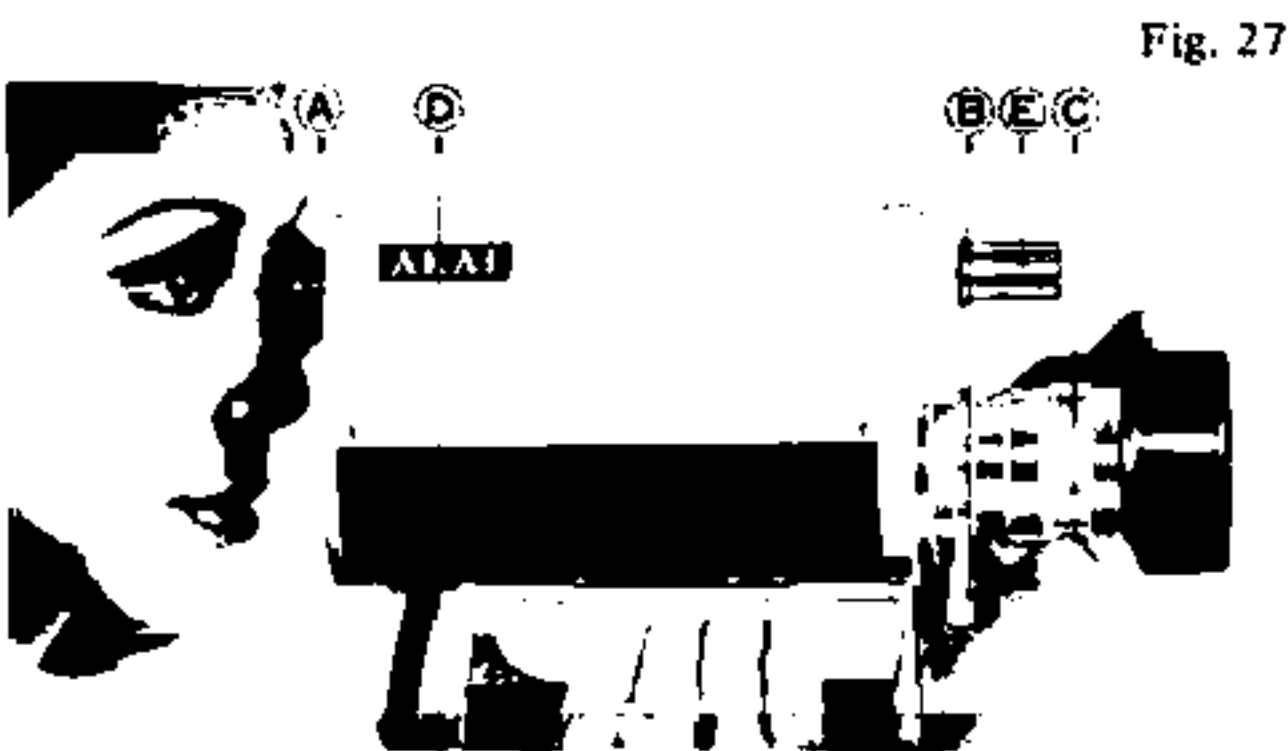
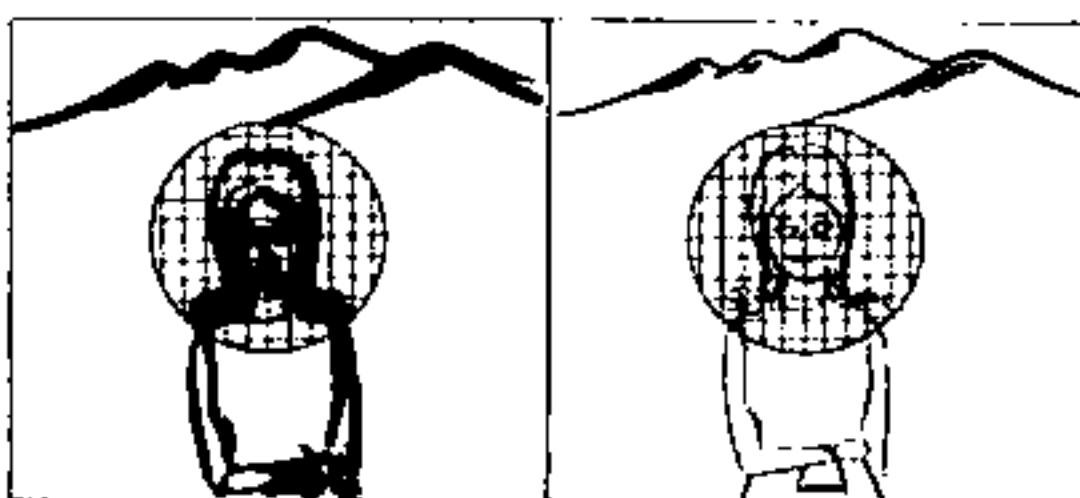

Fig. 27

Fig. 28



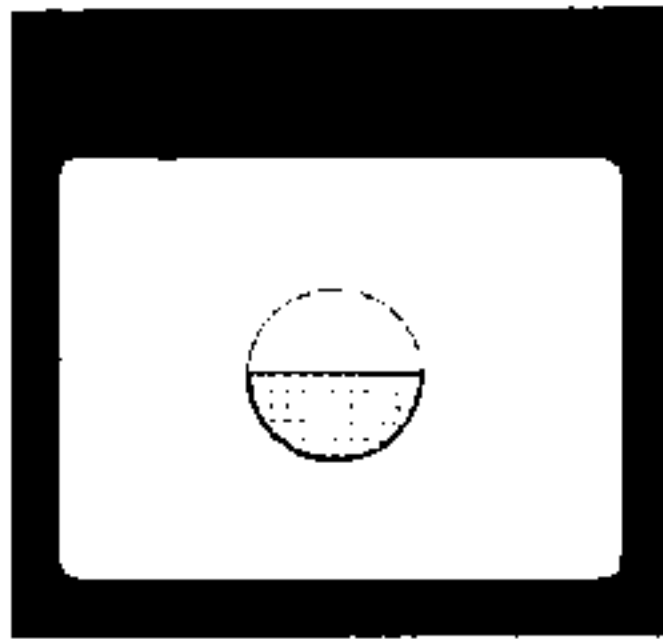

Fig. 29

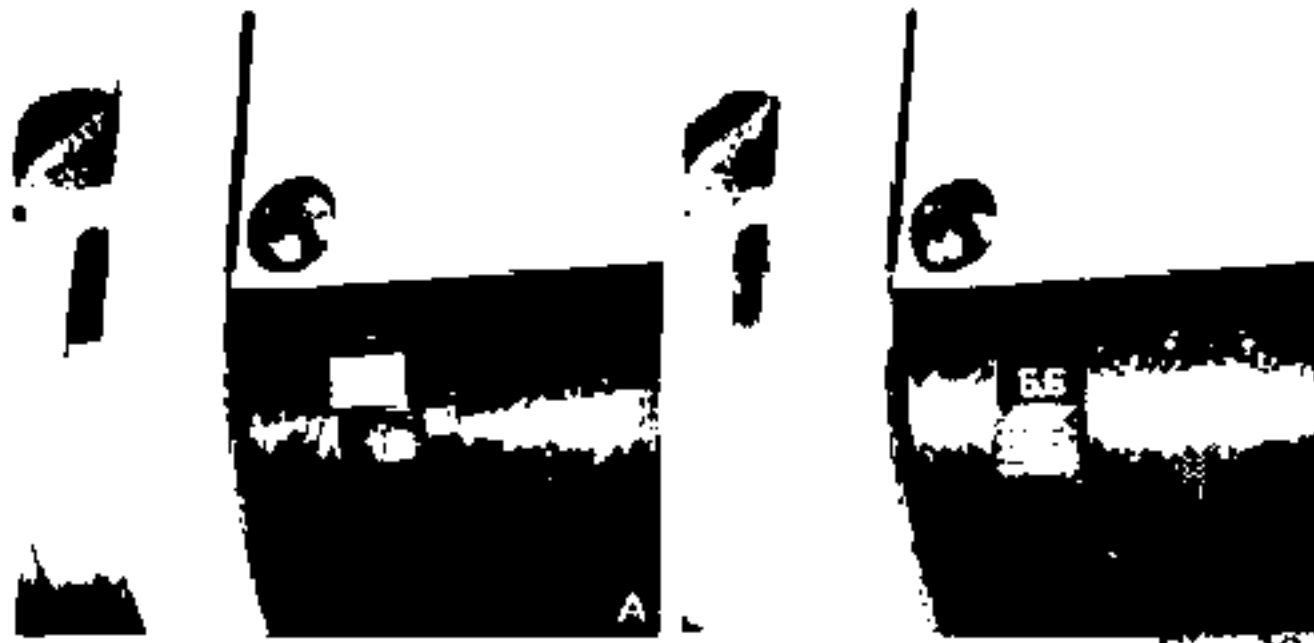

Fig. 30

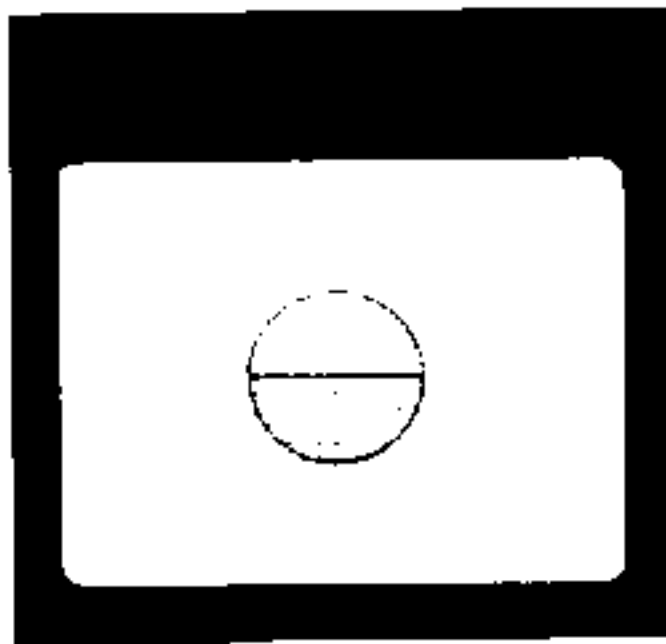

Fig. 31

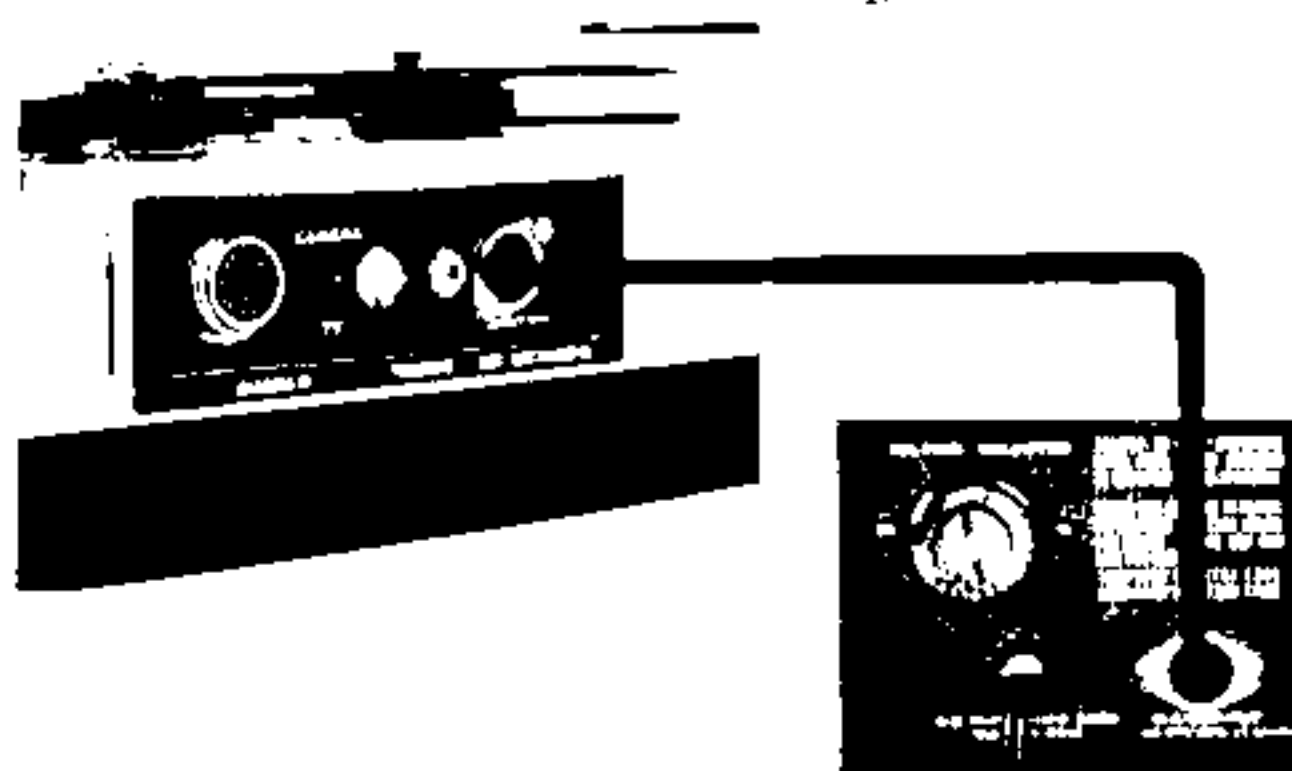

Fig. 32

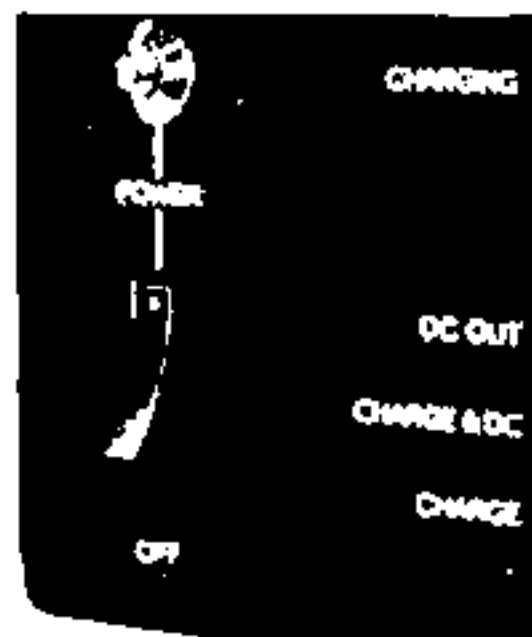

Fig. 33

■ TAPE INDICATOR LAMP

Your VC-110 is equipped with a Tape Indicator Lamp. When looking through the View Finder, a red indicator lamp can be seen at the lower edge of the finder frame. When the tape comes to the end or is accidentally broken, this indicator lamp will cut off.

■ APERTURE SWITCH

Set to 5.6 for outdoor use and to 1.8 for indoor use. If video monitor is attached, while viewing picture on video screen, set Aperture Switch to the more suitable position.

■ APERTURE SWITCH INDICATOR

When looking through View Finder, an indicator lamp can be seen at the upper edge of the finder frame. When Aperture Switch is set to 1.8 position, this indicator is white, and when set to 5.6 position, it is red.

8. VA-110 AC ADAPTER

Though Model VT-110 is equipped with rechargeable batteries, a second power source is readily available by using your VA-110 AC adapter. Simply attach the Adapter Connection Cord to the DC Output Jack of Adapter and Ext. Power-In Jack of the recorder as shown in Fig. 32.

When using the AC Adapter, set Power Switch on recorder to "BATT OFF/AC" position, and set Adapter Power Switch to "ON" position.

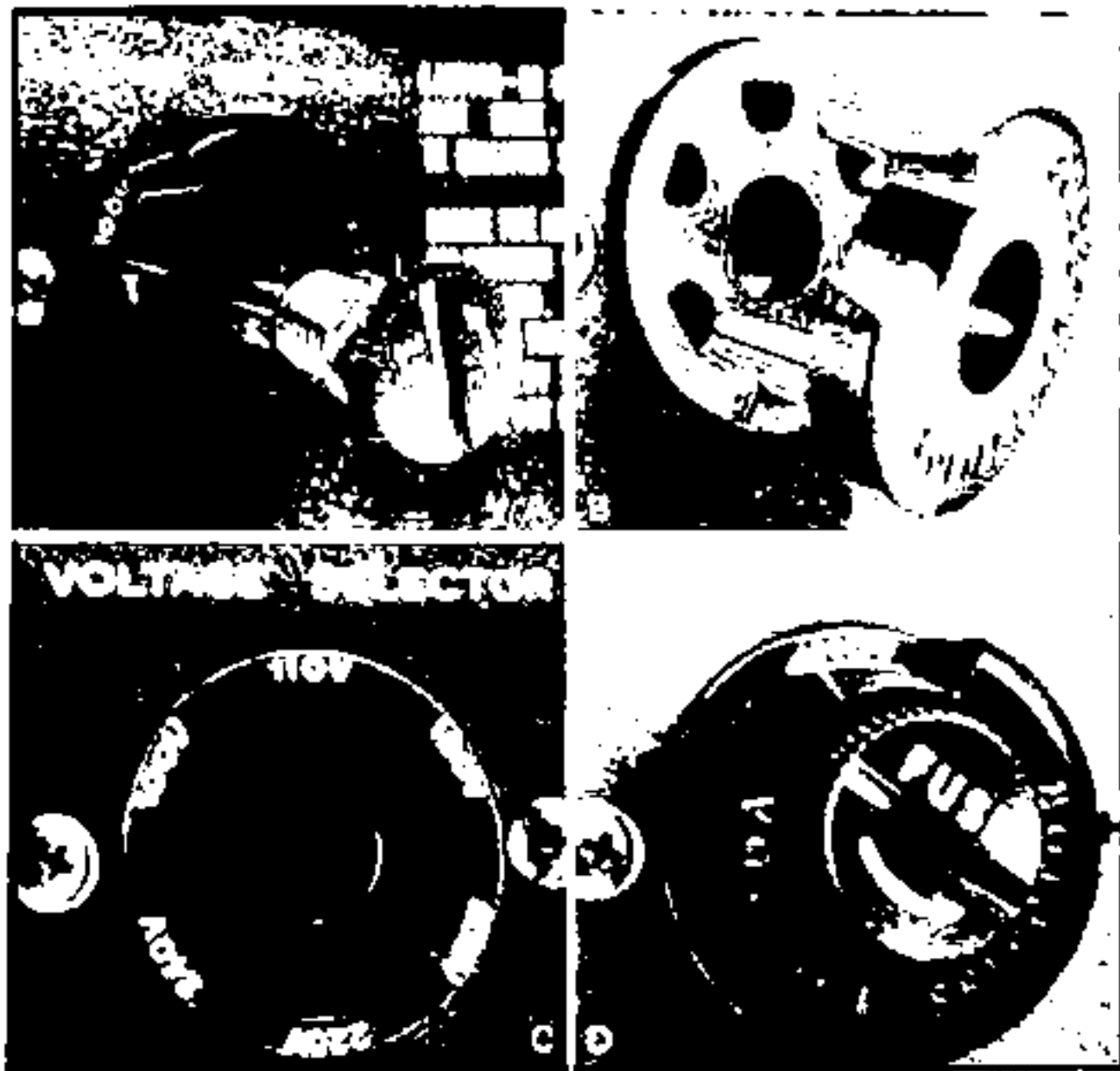

Fig. 34



Fig. 35



Fig. 36

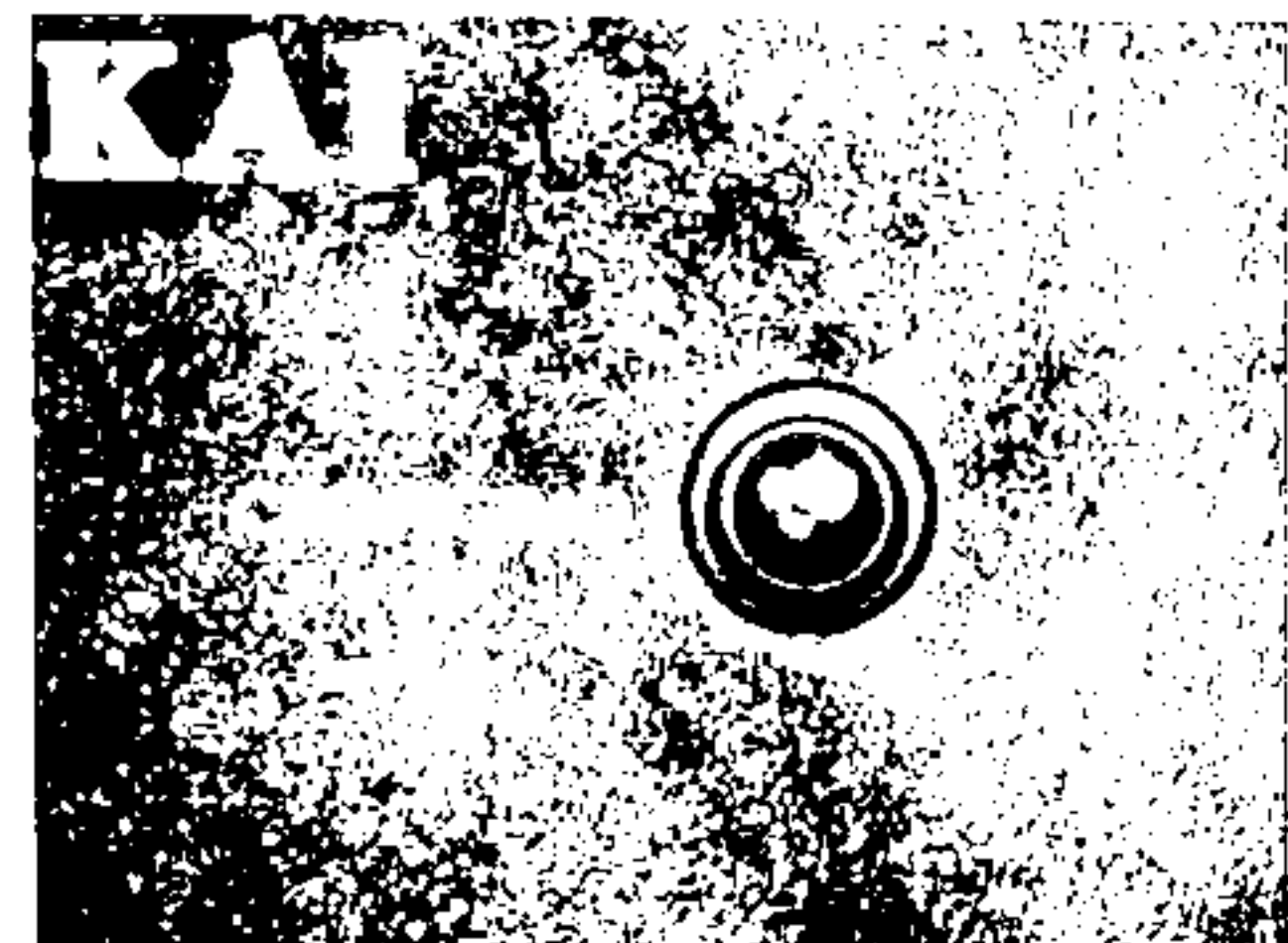

Fig. 37

■ ADAPTER POWER VOLTAGE ADJUSTMENT

Power voltage ranges from AC 100 to 240 volts. Each unit is pre-set at the factory to a specified voltage according to its destination. If necessary, please re-adjust the voltage as follows :

- 1) Remove the FUSE POST as shown in Fig. A. Remove the VOLTAGE SELECTOR PLUG and reinsert to required area voltage.
- 2) The VOLTAGE SELECTOR as shown in Figs. B, C, and D is a rotatable plug-in type offering six selections (100/110/120/200/220/240 V).
- 3) Change the fuse according to voltage
 Fuse : 100-120 V 1A - 125 V Fuse
 200-240 V 0.5A - 250 V Fuse

Caution :

Do not plug in AC Cord until voltage conversion has been made.

To maintain optimum performance and to prolong the life of your machine, the voltage should be kept within 10% deviation of standard area voltage.

(If standard voltage is between the levels indicated on the Voltage Selector, use the next higher step voltage level).

■ CHARGING BATTERIES

Your Adapter is also your battery charger. If the batteries are in their compartment, they can be recharged at the same time your adapter is being used as a power source.

1. Set VTR recorder Power Switch to "BATT OFF/AC" position.
2. When you operate Adapter only using AC source, set Selector Switch to "DC OUT" (upper position, Fig. A).
3. When you wish to operate Adapter and charge batteries) set Selector Switch to "CHARGE & DC" (middle position, Fig. B).
4. When you wish only to recharge batteries, set Selector Switch to "CHARGE" (lower position, Fig. C).

Battery charging time is 8 hours. Your adapter is equipped with a battery charging indicator lamp. When the batteries have been completely recharged, this lamp will go out (the lamp will become dark).

Notes :

1. Charge batteries before storing.
2. Recharge batteries every two months.
3. Store batteries in a cool dry place.

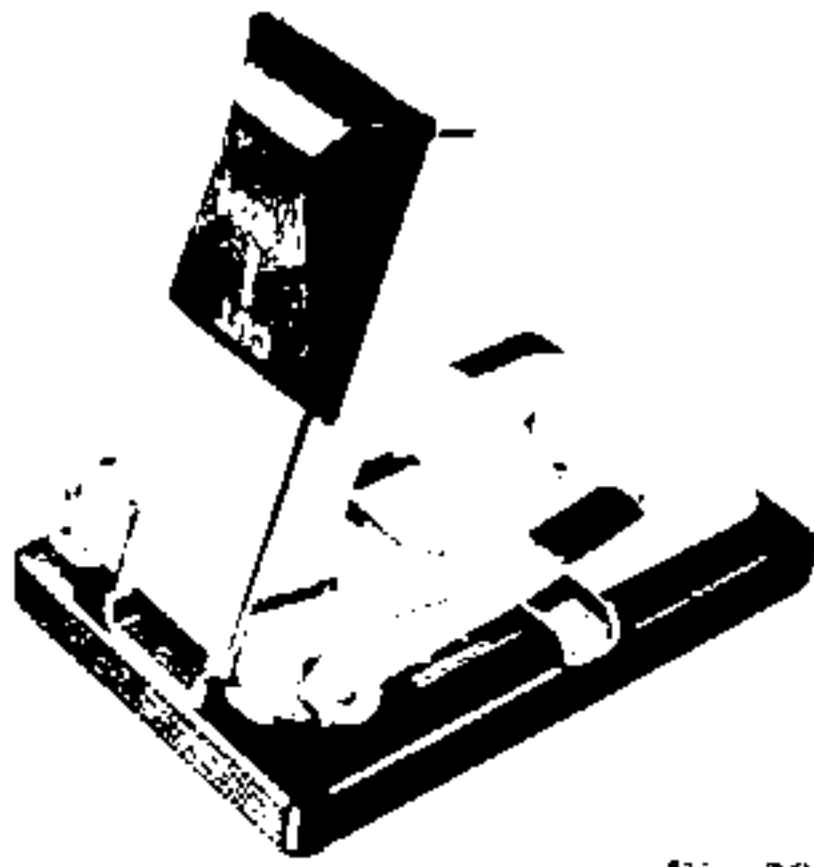

Fig. 38



Fig. 39

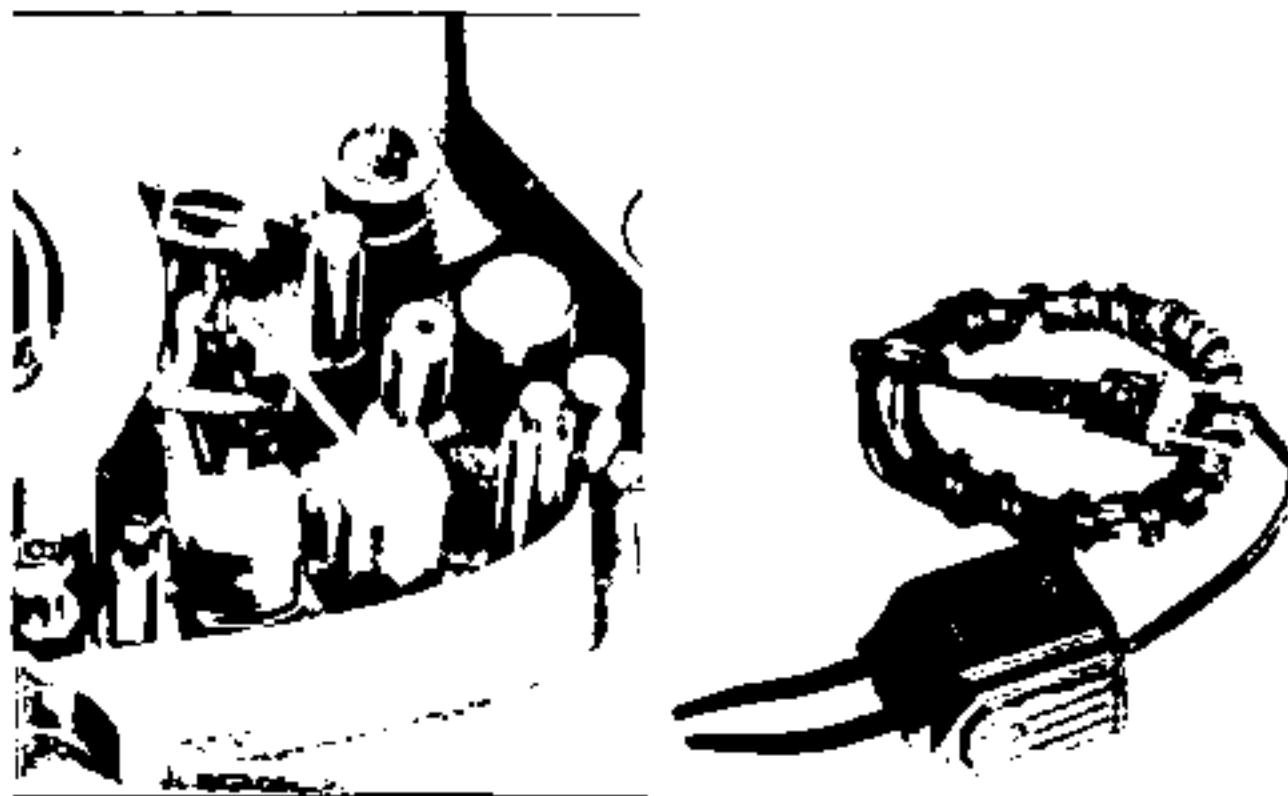

Fig. 40

9. TAPE SPLICING AND EDITING

Cut tape diagonally with an overlap so that the ends are lined up (cutting tape on diagonal eliminates detection of the splice in recording).

Cover aligned ends with SPLICING TAPE. Press firmly, exerting pressure to secure ends evenly. Trim off excess splicing tape (Cut into recording tape very slightly as illustrated by dotted lines. This eliminates the possibility of a sticky splice). Splicing of tape using scissors requires skillful work. With our specially designed PORTABLE SPLICER, splicing can be done very smoothly.

Caution :

It is imperative that splicing be completely smooth. If not, the video heads will be irreparably damaged.

10. TAPE ERASING

Any signal information previously recorded on a tape will be erased automatically as a new recording is made on the same tape. For erasing only, thread the tape, and set recorder to normal record position. There should be no plugs connected to recorder's input jacks. A BULK TAPE ERASER is recommended for quick and complete erasure (AKAI Model ATE-7 is highly recommended).

11. HEAD DEMAGNETIZING (STATIONARY HEADS ONLY)

Normally the steel pole pieces which form a part of the recording and playback heads become slightly magnetized. The effect of slight head magnetization is that it partially erases the tape, especially at high frequencies. Generally, this condition can be detected by the loss of high frequency response which cannot be corrected through head alignment. Severe magnetization (which may be caused by using magnetized tools in the vicinity of the heads) will result in noise or considerable distortion in addition to the loss of high frequency response. Although Model VT-110 already has a built-in Head Demagnetizing Circuit, it is recommended that head de-magnetizing be performed periodically. This can be accomplished by touching the heads lightly with the demagnetizer and making several small circular motions over all stationary head surface areas as well as the head housing.

Note :

To avoid scratching the head surface, we suggest that you cover both prongs of the head demagnetizer with a sort of masking tape.

Caution :

Do not attempt to demagnetize the Video Heads as they may be damaged.

12. ACCESSORIES

■ STANDARD ACCESSORIES

Leather Carrying Strap	1
Adapter/Recorder Connection Cord	1
5" Video Tape	1
5" Empty Reel	1
Camera Eye Cap	1
Chamois Cloth	1
6 V Type D Rechargeable Batteries	2
Spare Fuse	2
Operator's Manual	1

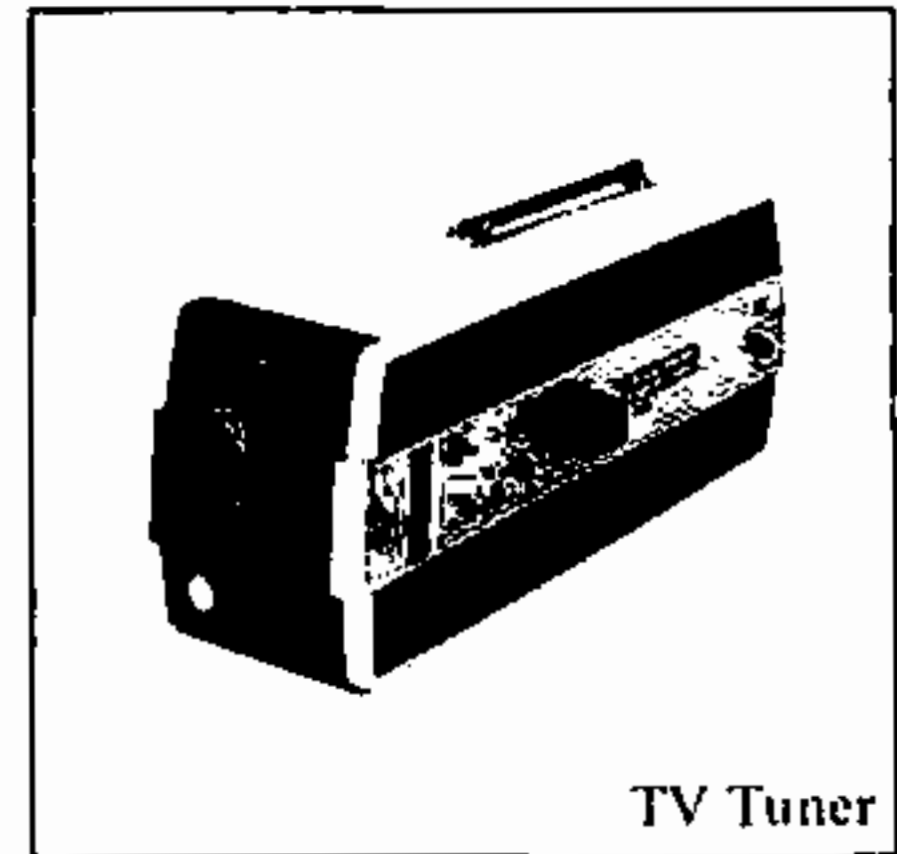

TV Tuner

■ OPTIONAL ACCESSORIES

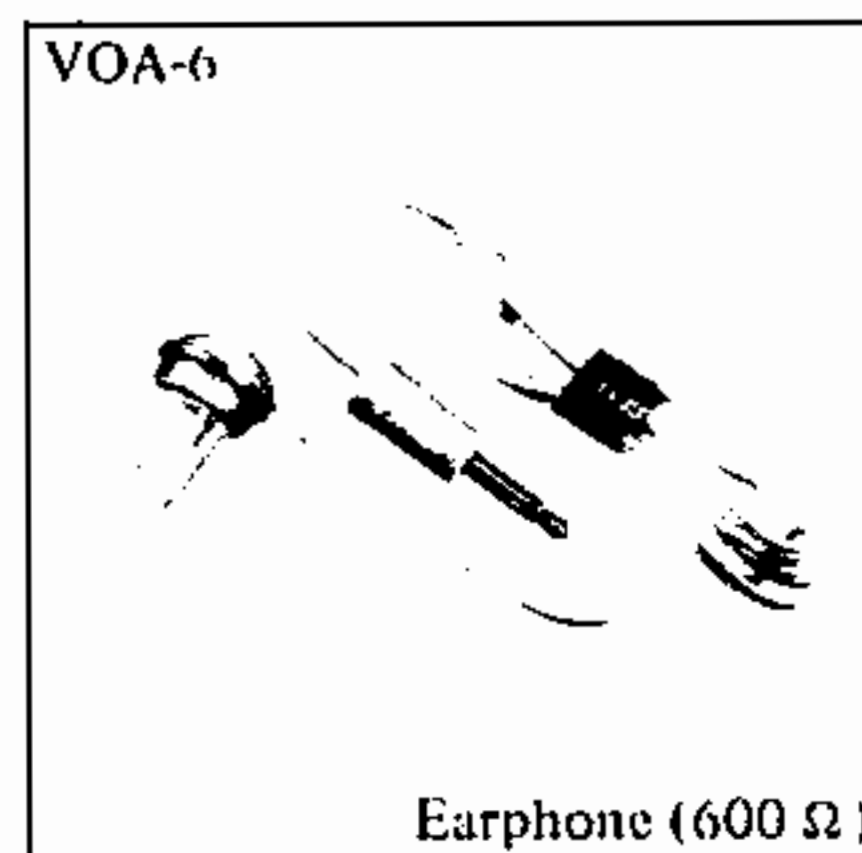
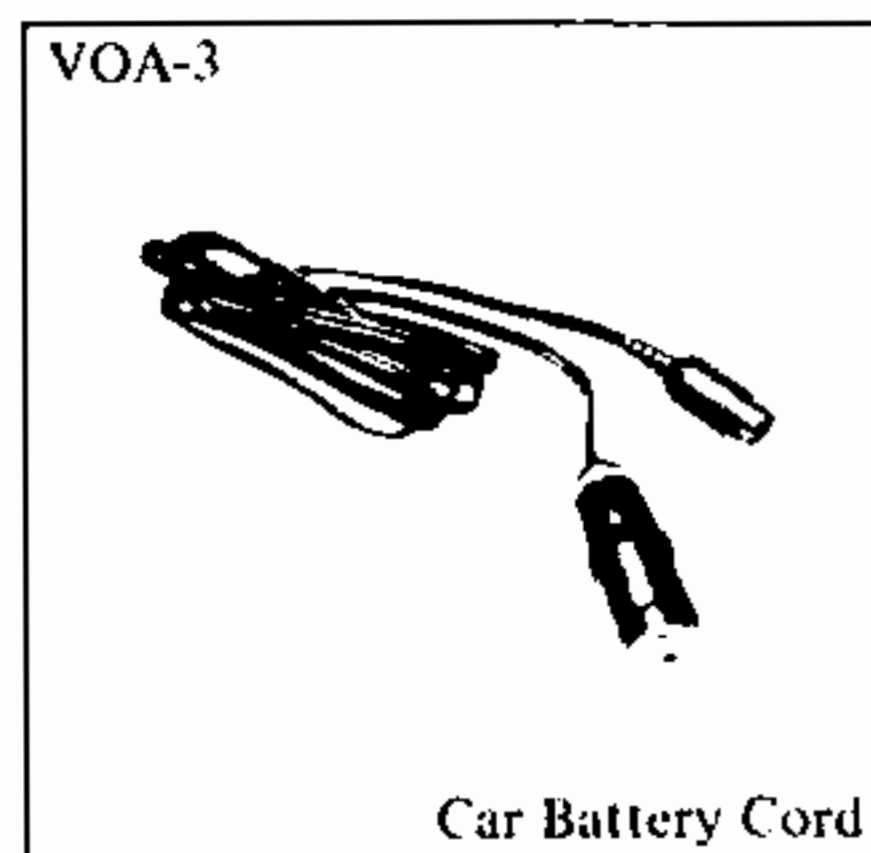
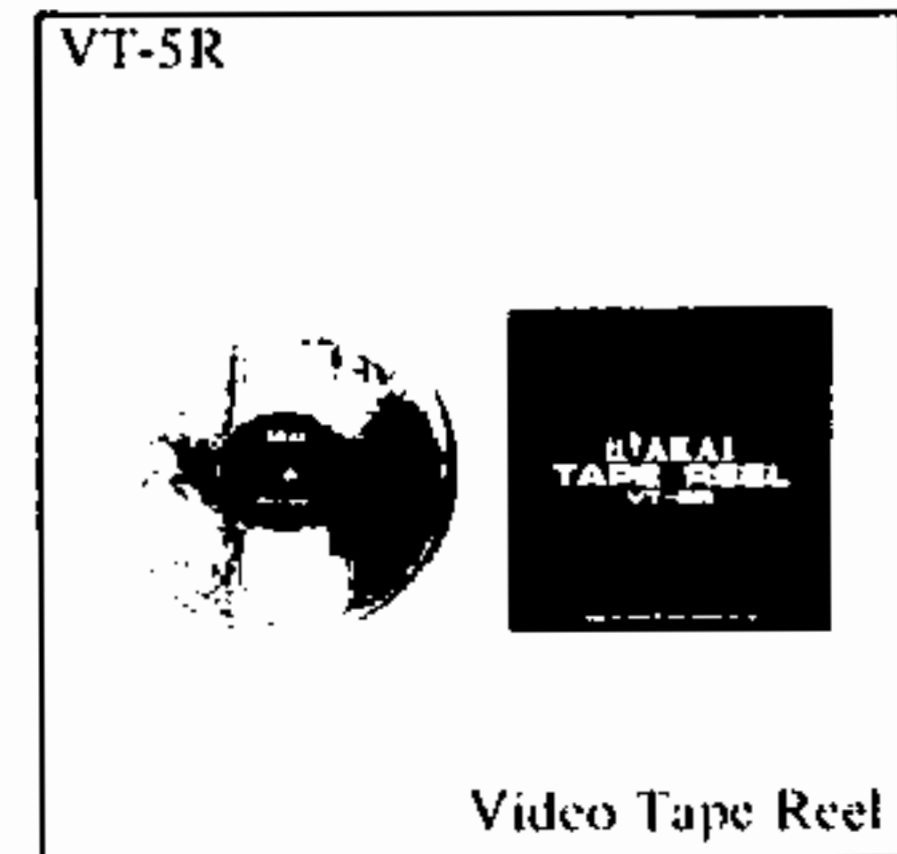
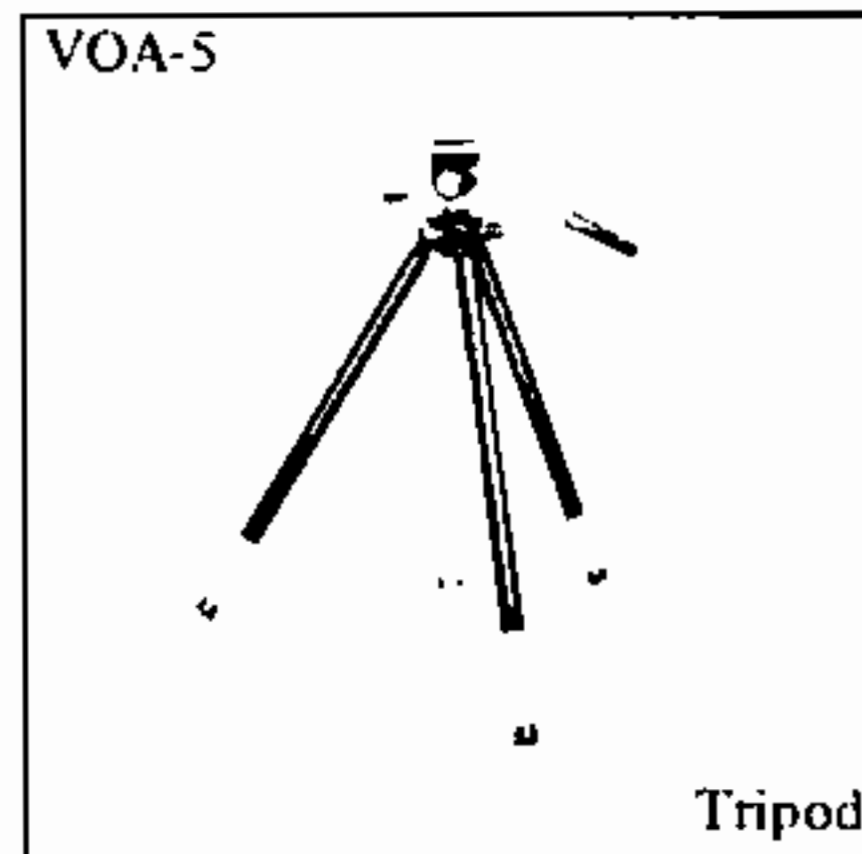
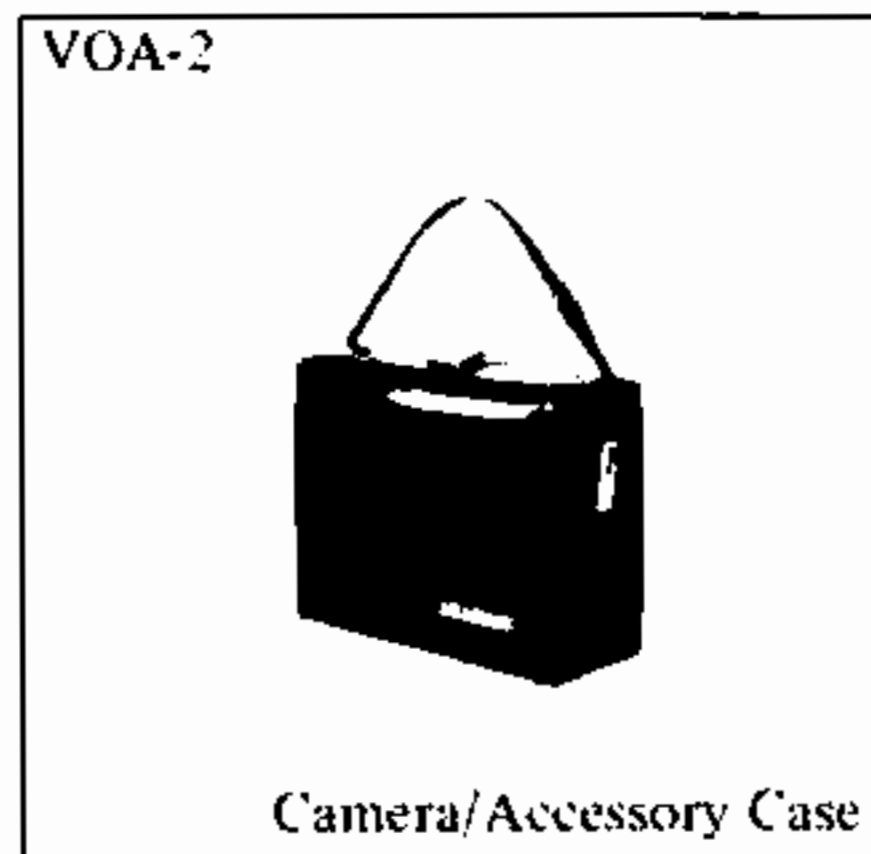
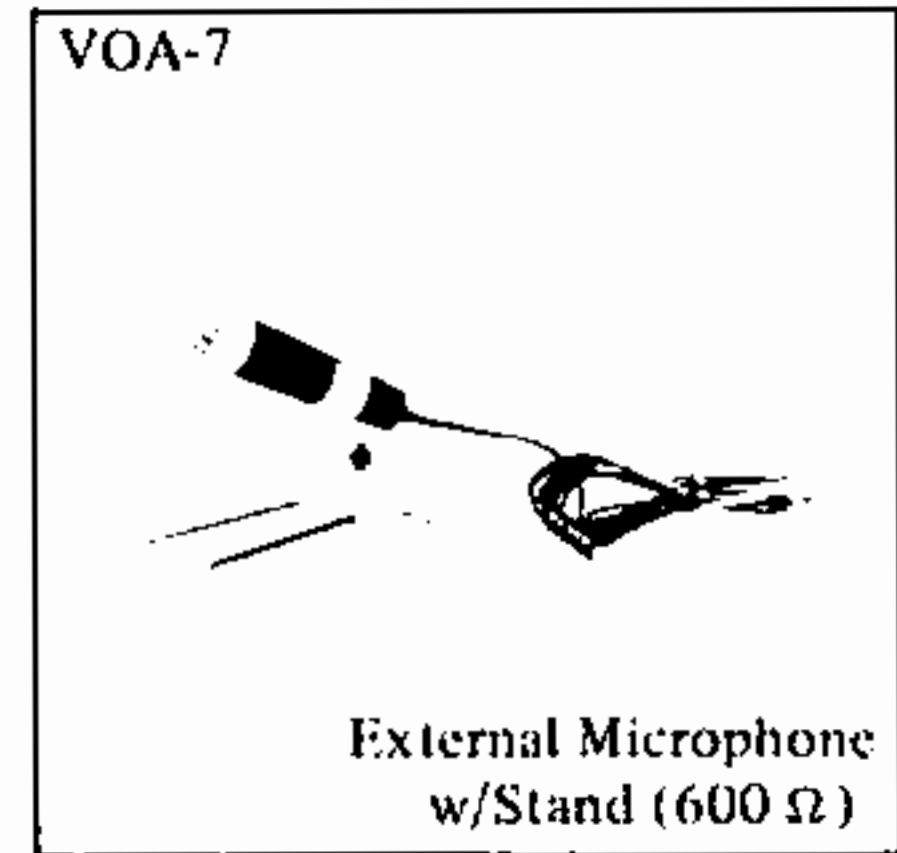
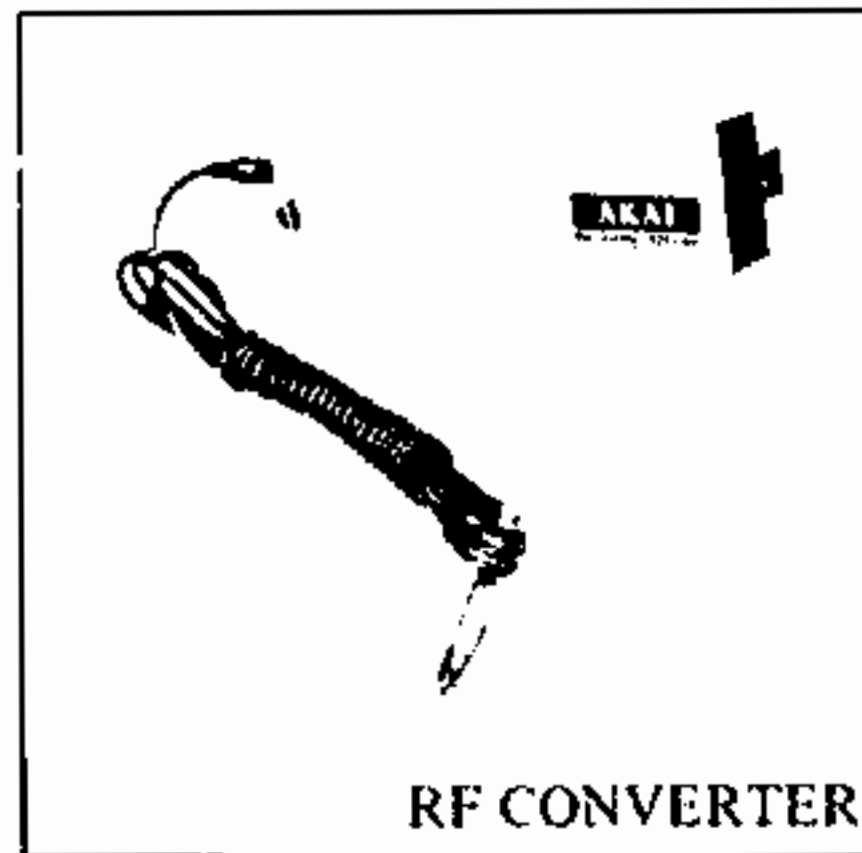
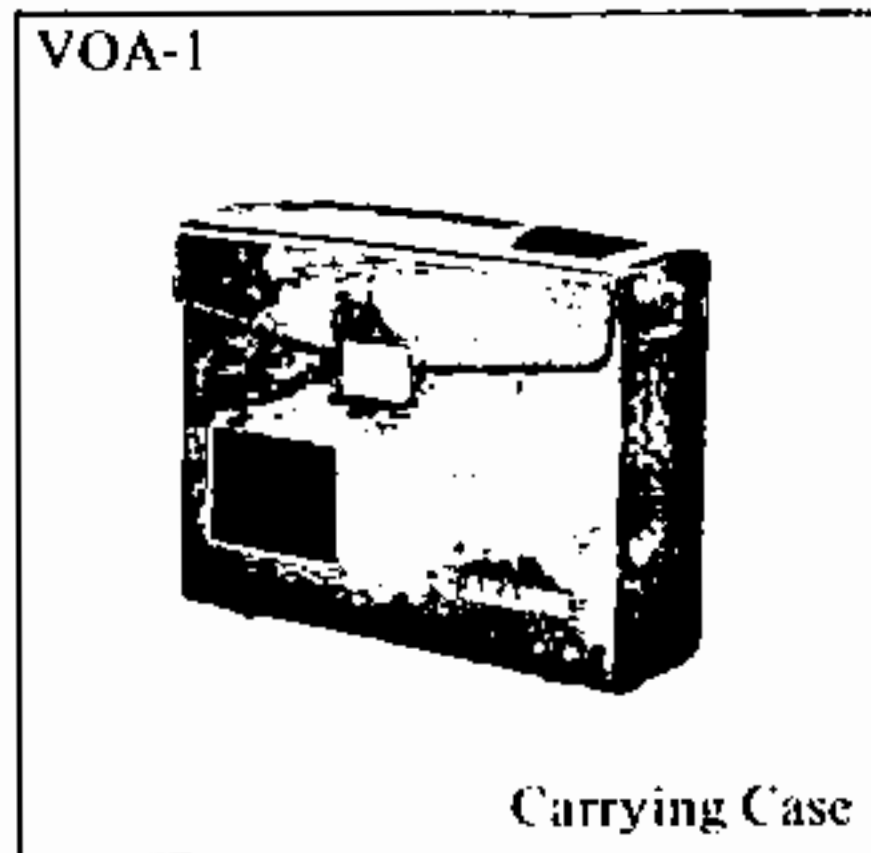



**MANUFACTURED & DISTRIBUTED BY
AKAI ELECTRIC CO., LTD.
AKAI TRADING CO., LTD.
12-14, 2-chome, Higashi-Kojiya,
Ohta-ku, Tokyo, Japan**

Price ¥ 360.00
US \$ 1.00



PRINTED IN JAPAN